ADVANTEST®

ADVANTEST CORPORATION

***R3267 Series OPT73
AMPS/JTACS/NTACS
Measurement Option
Operation Manual***

MANUAL NUMBER FOE-8370667B01

Applicable models

R3264

R3267

R3273

Safety Summary

To ensure thorough understanding of all functions and to ensure efficient use of this instrument, please read the manual carefully before using. Note that Advantest bears absolutely no responsibility for the result of operations caused due to incorrect or inappropriate use of this instrument.

If the equipment is used in a manner not specified by Advantest, the protection provided by the equipment may be impaired.

- **Warning Labels**

Warning labels are applied to Advantest products in locations where specific dangers exist. Pay careful attention to these labels during handling. Do not remove or tear these labels. If you have any questions regarding warning labels, please ask your nearest Advantest dealer. Our address and phone number are listed at the end of this manual.

Symbols of those warning labels are shown below together with their meaning.

DANGER: Indicates an imminently hazardous situation which will result in death or serious personal injury.

WARNING: Indicates a potentially hazardous situation which will result in death or serious personal injury.

CAUTION: Indicates a potentially hazardous situation which will result in personal injury or a damage to property including the product.

- **Basic Precautions**

Please observe the following precautions to prevent fire, burn, electric shock, and personal injury.

- Use a power cable rated for the voltage in question. Be sure however to use a power cable conforming to safety standards of your nation when using a product overseas.
- When inserting the plug into the electrical outlet, first turn the power switch OFF and then insert the plug as far as it will go.
- When removing the plug from the electrical outlet, first turn the power switch OFF and then pull it out by gripping the plug. Do not pull on the power cable itself. Make sure your hands are dry at this time.
- Before turning on the power, be sure to check that the supply voltage matches the voltage requirements of the instrument.
- Connect the power cable to a power outlet that is connected to a protected ground terminal. Grounding will be defeated if you use an extension cord which does not include a protected ground terminal.
- Be sure to use fuses rated for the voltage in question.
- Do not use this instrument with the case open.
- Do not place anything on the product and do not apply excessive pressure to the product. Also, do not place flower pots or other containers containing liquid such as chemicals near this

product.

- When the product has ventilation outlets, do not stick or drop metal or easily flammable objects into the ventilation outlets.
- When using the product on a cart, fix it with belts to avoid its drop.
- When connecting the product to peripheral equipment, turn the power off.

- **Caution Symbols Used Within this Manual**

Symbols indicating items requiring caution which are used in this manual are shown below together with their meaning.

DANGER: Indicates an item where there is a danger of serious personal injury (death or serious injury).

WARNING: Indicates an item relating to personal safety or health.

CAUTION: Indicates an item relating to possible damage to the product or instrument or relating to a restriction on operation.

- **Safety Marks on the Product**

The following safety marks can be found on Advantest products.



: ATTENTION - Refer to manual.



: Protective ground (earth) terminal.



: DANGER - High voltage.



: CAUTION - Risk of electric shock.

- **Replacing Parts with Limited Life**

The following parts used in the instrument are main parts with limited life.

Replace the parts listed below before their expected lifespan has expired to maintain the performance and function of the instrument.

Note that the estimated lifespan for the parts listed below may be shortened by factors such as the environment where the instrument is stored or used, and how often the instrument is used.

The parts inside are not user-replaceable. For a part replacement, please contact the Advantest sales office for servicing.

Each product may use parts with limited life.

For more information, refer to the section in this document where the parts with limited life are described.

Main Parts with Limited Life

Part name	Life
Unit power supply	5 years
Fan motor	5 years
Electrolytic capacitor	5 years
LCD display	6 years
LCD backlight	2.5 years
Floppy disk drive	5 years
Memory backup battery	5 years

- **Hard Disk Mounted Products**

The operational warnings are listed below.

- Do not move, shock and vibrate the product while the power is turned on.
Reading or writing data in the hard disk unit is performed with the memory disk turning at a high speed. It is a very delicate process.
- Store and operate the products under the following environmental conditions.
An area with no sudden temperature changes.
An area away from shock or vibrations.
An area free from moisture, dirt, or dust.
An area away from magnets or an instrument which generates a magnetic field.
- Make back-ups of important data.
The data stored in the disk may become damaged if the product is mishandled. The hard disc has a limited life span which depends on the operational conditions. Note that there is no guarantee for any loss of data.

- **Precautions when Disposing of this Instrument**

When disposing of harmful substances, be sure dispose of them properly with abiding by the state-provided law.

Harmful substances: (1) PCB (polycarbon biphenyl)
(2) Mercury
(3) Ni-Cd (nickel cadmium)
(4) Other
Items possessing cyan, organic phosphorous and hexadic chromium and items which may leak cadmium or arsenic (excluding lead in solder).

Example: fluorescent tubes, batteries

Environmental Conditions

This instrument should be only be used in an area which satisfies the following conditions:

- An area free from corrosive gas
- An area away from direct sunlight
- A dust-free area
- An area free from vibrations
- Altitude of up to 2000 m

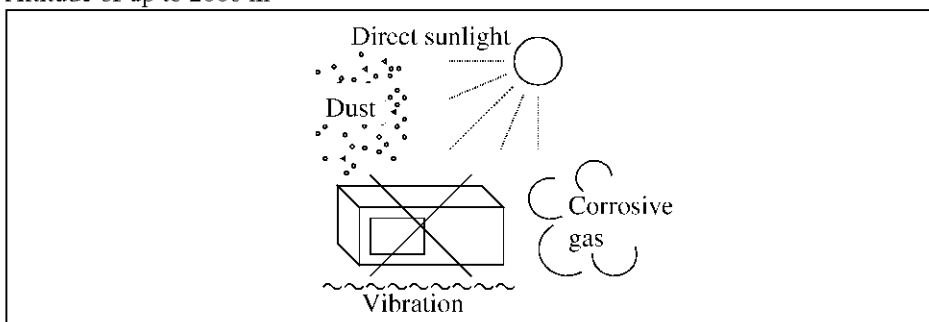

Figure-1 Environmental Conditions

- Operating position

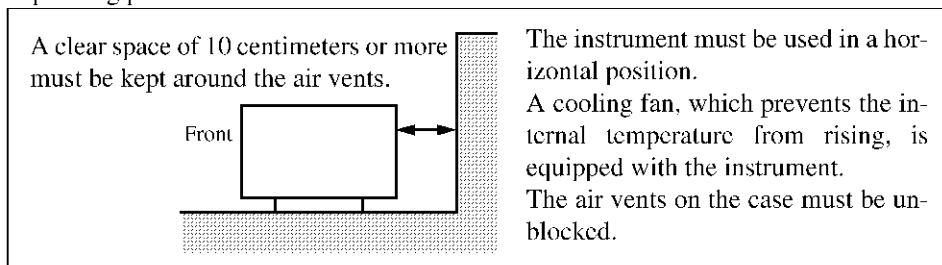

Figure-2 Operating Position

- Storage position

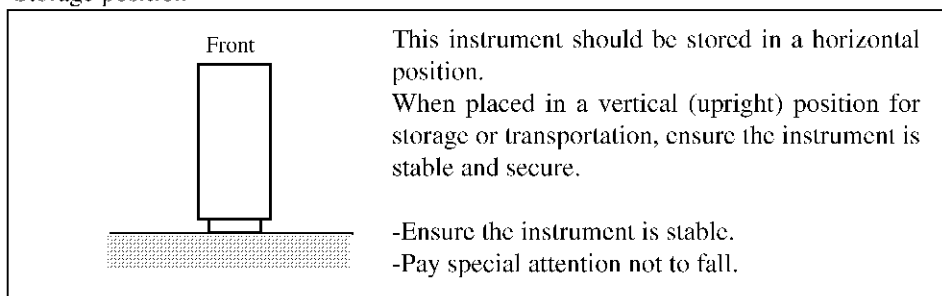

Figure-3 Storage Position

- The classification of the transient over-voltage, which exists typically in the main power supply, and the pollution degree is defined by IEC61010-1 and described below.

Impulse withstand voltage (over-voltage) category II defined by IEC60364-4-443

Pollution Degree 2

Types of Power Cable

Replace any references to the power cable type, according to the following table, with the appropriate power cable type for your country.

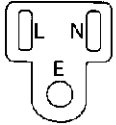
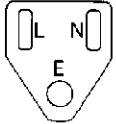
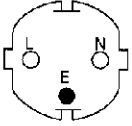
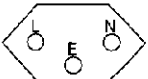
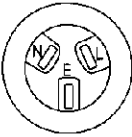
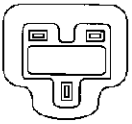
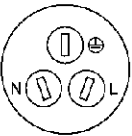
Plug configuration	Standards	Rating, color and length	Model number (Option number)
	PSE: Japan Electrical Appliance and Material Safety Law	125 V at 7 A Black 2 m (6 ft)	Straight: A01402 Angled: A01412
	UL: United States of America CSA: Canada	125 V at 7 A Black 2 m (6 ft)	Straight: A01403 (Option 95) Angled: A01413
	CEE: Europe DEMKO: Denmark NEMKO: Norway VDE: Germany KEMA: The Netherlands CEBEC: Belgium OVE: Austria FIMKO: Finland SEMKO: Sweden	250 V at 6 A Gray 2 m (6 ft)	Straight: A01404 (Option 96) Angled: A01414
	SEV: Switzerland	250 V at 6 A Gray 2 m (6 ft)	Straight: A01405 (Option 97) Angled: A01415
	SAA: Australia, New Zealand	250 V at 6 A Gray 2 m (6 ft)	Straight: A01406 (Option 98) Angled: -----
	BS: United Kingdom	250 V at 6 A Black 2 m (6 ft)	Straight: A01407 (Option 99) Angled: A01417
	CCC: China	250 V at 10 A Black 2 m (6 ft)	Straight: A114009 (Option 94) Angled: A114109

PREFACE

This manual provides the information necessary to check functionality, operate and program the R3267 Series Option 73, AMPS/JTACS/NTACS measurement.

(1) Organization of this manual

This manual consists of the following chapters:

Safety Summary	To use the analyzer safely, be sure to read this manual first.
1. Introduction <ul style="list-style-type: none"> • Product Overview • Accessories • Self Test Function • About Calibration • Explanation of the Connectors 	Includes a description of the option and its' parts and a self test error.
2. Operation	You can learn the basic operations of the option through the examples shown in this chapter.
3. Reference <ul style="list-style-type: none"> • Menu Index • Menu Map • Functional Description 	Shows a list of operation keys, and describes the function of each key.
4. Remote Control <ul style="list-style-type: none"> • GPIB 	Included are a list of commands necessary for programming.
5. Technical Information <ul style="list-style-type: none"> • About the Measurement Result • About De-Emphasis Filter Time Constant • Template Edit Function • Measurement Parameter Settings in ACP Due to Transient and Inband Spurious • Block Diagram 	Describes the principle of operation necessary for taking measurements more accurately.
6. Performance Verification Test	Describes how to test performance.
7. Specifications	Shows the specifications of the option.
APPENDIX <ul style="list-style-type: none"> • Messages 	If an error occurs during operation, an error number and its corresponding error message are displayed. The meaning of each error is explained in this section.

(2) Typeface conventions used in this manual

- Panel keys and soft keys are printed in a contrasting typeface to make them stand out from the text as follows:

Panel keys: Boldface type

Example: **TRANSIENT**

Soft keys: Boldface and italic type

Example: ***Detector***

- When a series of key operations are described using a comma between two keys.
- There are various soft menus used to switch between two states such as ON/OFF and AUTO/MNL. For example, when turning MNL the ***RBW AUTO/MNL*** function, the annotation "***RBW AUTO/MNL(MNL)***" is used.

TABLE OF CONTENTS

1	INTRODUCTION	1-1
1.1	Product Overview	1-1
1.2	Accessories	1-1
1.3	Self Test Function	1-1
1.4	About Calibration	1-1
1.5	Explanation of the Connectors	1-1
2	OPERATION	2-1
2.1	Measuring the Frequency Deviation of an FM Signal	2-1
3	REFERENCE	3-1
3.1	Menu Index	3-1
3.2	Menu Map	3-4
3.3	Functional Description	3-14
3.3.1	Switching Communication Systems	3-15
3.3.2	T-Domain	3-15
3.3.2.1	Power (T-Domain)	3-16
3.3.2.2	ON/OFF Ratio	3-19
3.3.2.3	Spurious (T-Domain)	3-21
3.3.3	F-Domain	3-23
3.3.3.1	Power (F-Domain)	3-23
3.3.3.2	OBW	3-26
3.3.3.3	ACP Due to Transient	3-27
3.3.3.4	Inband Spurious	3-29
3.3.3.5	Outband Spurious	3-31
3.3.4	Modulation	3-33
3.3.4.1	FM Deviation	3-33
3.3.4.2	Tx Power	3-34
3.3.4.3	Time & FFT	3-35
3.3.5	STD	3-36
3.3.5.1	DC CAL	3-36
3.3.5.2	Channel Setting	3-36
3.3.5.3	STD Setup	3-36
4	REMOTE CONTROL	4-1
4.1	GPIB Command Index	4-1
4.2	GPIB Command Codes	4-6
5	TECHNICAL INFORMATION	5-1
5.1	About the Measurement Result	5-1
5.2	About De-Emphasis Filter Time Constant	5-2

Table of Contents

5.3	Template Edit Function	5-3
5.3.1	Template Setting in the T-Domain Measuring Mode	5-3
5.3.2	Template Setting in the F-Domain Measuring Mode	5-5
5.4	Measurement Parameter Settings in ACP Due to Transient and Inband Spurious	5-7
5.4.1	Marker Edit Function	5-7
5.4.2	Measurement results Using ACP Due to Transient and Inband Spurious Modes	5-8
5.4.3	Measurement Result of Inband Spurious	5-9
5.5	Block Diagram	5-10
6	PERFORMANCE VERIFICATION TEST	6-1
6.1	General	6-1
6.1.1	Introduction	6-1
6.1.2	Test Equipment	6-1
6.1.3	Calibration Cycle	6-2
6.1.4	Performance Verification Test Record Sheets	6-2
6.1.5	Performance Verification Procedure	6-2
6.2	Performance Verification Test Procedure	6-3
6.2.1	FM Deviation	6-3
6.2.2	Simplified Performance Check	6-6
6.3	Performance Verification Record Sheet	6-8
6.4	Performance Check Record Sheet	6-8
7	SPECIFICATIONS	7-1
	APPENDIX	A-1
A.1	Messages	A-1
	ALPHABETICAL INDEX	I-1

LIST OF ILLUSTRATIONS

No.	Title	Page
2-1	Connections for Measurements	2-1
2-2	Spectrum of FM Signal	2-2
2-3	Parameter setup Dialog box	2-2
2-4	Numeric Display of Measurement Results	2-3
2-5	Example of a Graphic Time-Freq Display	2-4
2-6	Example of an FFT of Dmd Display	2-4
3-1	Dialog Box Used for the Communication Systems	3-15
3-2	Trigger Setup Dialog Box	3-16
3-3	Parameter Setup Dialog Box	3-18
3-4	Trigger Setup Dialog Box	3-19
3-5	Parameter Setup Dialog Box	3-20
3-6	Trigger Setup Dialog Box	3-21
3-7	Parameter Setup Dialog Box	3-22
3-8	Trigger Setup Dialog Box	3-23
3-9	Detector Dialog Box	3-25
3-10	Parameter Setup Dialog Box	3-25
3-11	Parameter Setup Dialog Box	3-26
3-12	Parameter Setup Dialog Box	3-28
3-13	Parameter Setup Dialog Box	3-30
3-14	Parameter Setup Dialog Box	3-32
3-15	Parameter Dialog Box	3-33
3-16	Parameter Setup Dialog Box	3-34
3-17	Parameter Setup Dialog Box	3-35
3-18	STD Measurement Parameter Set Dialog Box	3-36
5-1	Template to Be Set	5-3
5-2	Template settings	5-4
5-3	Template Shifted Using the Shift Y Function	5-4
5-4	Template with the Set Values	5-5
5-5	Template with Margin Delta X	5-5
5-6	Example of Marker Edit Setting	5-7
5-7	Marker Edit Setting	5-8
5-8	Example of Peak Marker Y Delta	5-8
5-9	Block Diagram	5-10
6-1	Setup of FM Deviation Test	6-3
6-2	Display of Searching the Minimum FM Deviation	6-4
6-3	Setup of Measurement Parameters for FM Deviation Test	6-4
6-4	Setup of Simplified Performance Check	6-6
6-5	Setup of Measurement Parameters for Simplified Performance Check	6-7

LIST OF TABLES

No.	Title	Page
4-1	Operating mode	4-6
4-2	ATT key (Attenuator)	4-6
4-3	COPY key (Hand copy)	4-6
4-4	COUPLE key (Couple function)	4-7
4-5	FREQ key (Frequency)	4-7
4-6	LEVEL key (Reference Level)	4-7
4-7	MKR key (Marker)	4-8
4-8	PRESET Key (Initialization)	4-8
4-9	RCL Key (Recall)	4-8
4-10	SAVE Key (Save)	4-9
4-11	SPAN Key (Frequency span)	4-9
4-12	TRANSIENT Key	4-10
4-13	Numeric keys/Step keys/Data knob/Unit keys (Entering data)	4-29
4-14	Miscellaneous	4-30
6-1	Performance Verification Items	6-1
6-2	Equipment List	6-1
6-3	Setting for FM Deviation Test	6-5

1 INTRODUCTION

1.1 Product Overview

The AMPS/JTACS/NTACS option(Option 73) software is designed to measure the frequency deviation of a frequency modulated signal.

This option is a factory option which is incorporated into the R3267 Series Spectrum Analyzer prior to shipment.

The key features of this option allow the user to:

- Measure the signals used in the AMPS,JTACS and NTACS analog wireless communication systems.
- Measure the frequency deviation of a frequency modulated signal and analyze demodulated audio signals.

1.2 Accessories

Name of accessories	Type of name	Quantity	Remarks
R3267 Series OPT73 Operation manual	ER3267/73 OPT73	1	English

1.3 Self Test Function

The self test also checks the Option 73 for correct operation when the spectrum analyzer power is turned on. The message shown below will be displayed when an error related to Option 73 occurs. Contact ADVANTEST Corp. for repair.

Error Message
Handshake error occurred to DSP

1.4 About Calibration

When you want to calibrate the R3267 Series, please contact a sales representative.

Desirable Period	One year
------------------	----------

1.5 Explanation of the Connectors

Connectors used for this option are described as follows:

- EXT TRIG terminal Connector for inputting the external trigger signal.

2 OPERATION

This chapter describes how to use this option by giving a practical measurement example.

2.1 Measuring the Frequency Deviation of an FM Signal

This section describes how to measure the FM signal's frequency regardless of communication systems.

Carrier Frequency: 921.25MHz

Setup

1. Connect the instrument as shown in Figure 2-1.

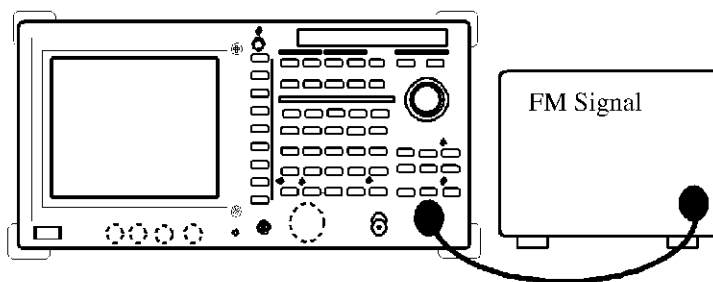

Figure 2-1 Connections for Measurements

Checking the signal

This example does not require STD setup because signals regardless of communication systems are measured.

2. Press **POWER** to switch to the SPA mode.
3. Press **FREQ** and set 921.25MHz.
4. Press **SPAN** and set 200kHz.
5. Press **COUPLE** and **RBW AUTO/MNL(AUTO)** to set the RBW to AUTO.
6. Press **VBW AUTO/MNL(AUTO)** to set the VBW to AUTO.
7. Press **Sweep Time AUTO/MNL(AUTO)** to set the Sweep Time to AUTO.

2.1 Measuring the Frequency Deviation of an FM Signal

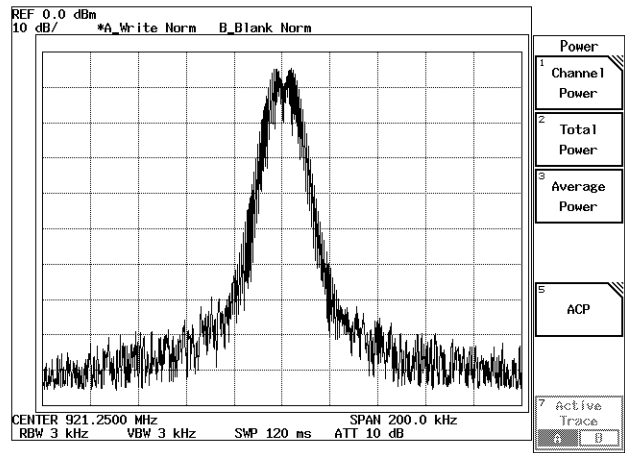

Figure 2-2 Spectrum of FM Signal

Measuring deviation of FM signal

8. Press **TRANSIENT**, *Modulation*, and *FM Deviation* to open the FM deviation analysis menu.
9. Press *Parameter Setup* to open the Parameter setup Dialog box.

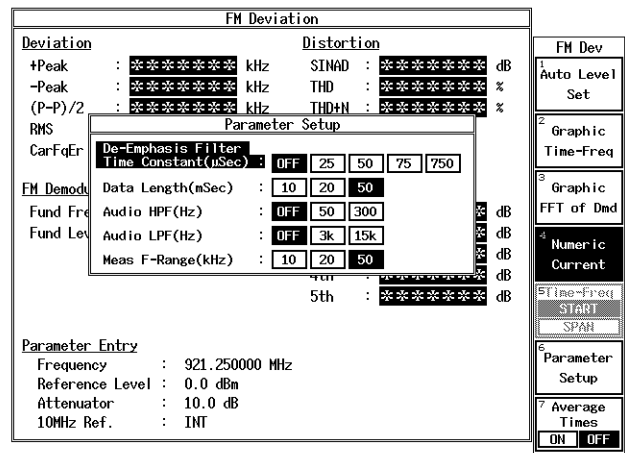

Figure 2-3 Parameter setup Dialog box

10. Select OFF from *De-Emphasis Filter Time Constant* using the data knob, and press the data knob (or **ENTR**) to set the parameter.
11. Select 50 from *Data Length(msec)* using the data knob, and press the data knob (or **ENTR**) to set the parameter.

2.1 Measuring the Frequency Deviation of an FM Signal

12. Select OFF from *Audio HPF(Hz)* using the data knob, and press the data knob (or **ENTR**) to set the parameter.
13. Select OFF from *Audio LPF(Hz)* using the data knob, and press the data knob (or **ENTR**) to set the parameter.
14. Select 50 from *Meas F-Range* using the data knob, and press the data knob (or **ENTR**) to set the parameter.
15. Press *Parameter Setup* to close the dialog box.

Executing Auto Level Set

16. Press *Auto Level Set* and wait until the message "Auto Level Completed!" is displayed.

Executing the measurement

17. Press **SINGLE** to start the measurement.

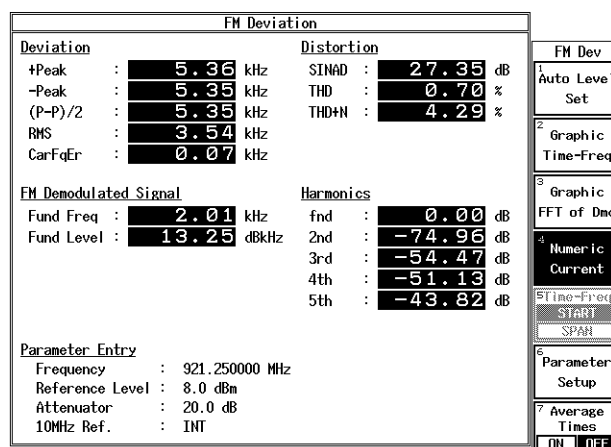

Figure 2-4 Numeric Display of Measurement Results

18. Press *Graphic Time-Freq* to display the frequency deviation on the vertical axis and time on the horizontal axis.

2.1 Measuring the Frequency Deviation of an FM Signal

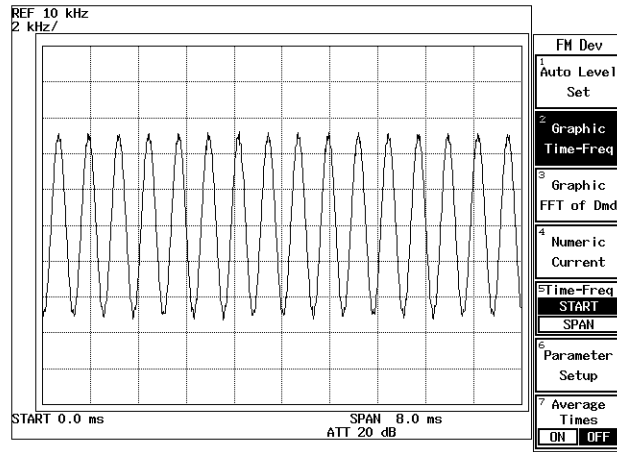

Figure 2-5 Example of a Graphic Time-Freq Display

19. Press **MKR** to display the marker. Move the marker by turning the data knob.
20. Press **SHIFT** and **MKR** to delete the marker. Press **RETURN** to return to the measurement menu.
21. Press *Graphic FFT of Dmd* to display the FFT of the demodulated data. (FFT of the data which is displayed on the Graphic Time-Freq.)

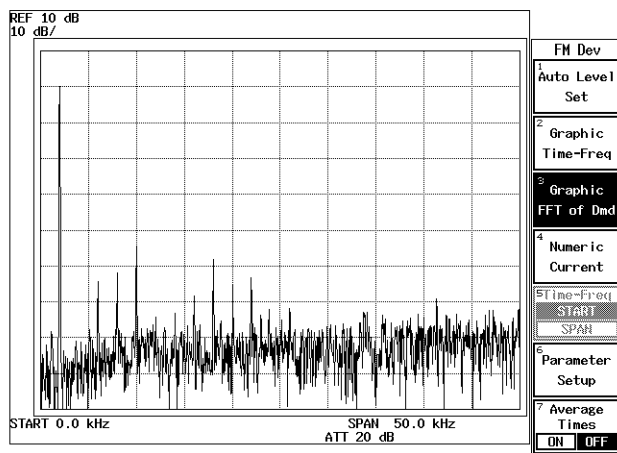

Figure 2-6 Example of an FFT of Dmd Display

3 REFERENCE

This chapter describes the functions of the panel and soft keys for option 73 software.

3.1 Menu Index

This menu index is used to easily find the keys described in Chapter 3.

ACP Due to Transient.....	3-4, 3-10	De-Emphasis Filter Time Constant	3-13, 3-33
Audio HPF.....	3-13, 3-34	Delay Time	3-5, 3-6,
Audio LPF.....	3-13, 3-34		3-7, 3-8,
Auto Level Set	3-5, 3-6,		3-16, 3-19,
	3-7, 3-8,	Delete Line	3-21, 3-24
	3-9, 3-10,		3-5, 3-7,
	3-11, 3-12,		3-10, 3-11,
	3-13, 3-16,		3-12, 3-17,
	3-19, 3-21,		3-22, 3-27,
	3-23, 3-26,		3-29, 3-30,
	3-27, 3-29,		3-32
	3-31, 3-33,	Detector	3-5, 3-6,
	3-34, 3-35		3-7, 3-8,
Average Times ON/OFF.....	3-5, 3-6,		3-9, 3-10,
	3-7, 3-8,		3-11, 3-12,
	3-9, 3-10,		3-18, 3-20,
	3-11, 3-12,		3-22, 3-25,
	3-13, 3-18,		3-26, 3-28,
	3-20, 3-22,		3-30, 3-32
	3-25, 3-26,	Display Unit.....	3-5, 3-6,
	3-27, 3-30,		3-7, 3-8,
	3-32, 3-34,		3-10, 3-11,
	3-35		3-12, 3-18,
Channel Setting.....	3-4, 3-13,		3-20, 3-22,
	3-36		3-25, 3-28,
Config	3-5, 3-6,		3-31, 3-32
	3-7, 3-8,	Ext Gate	3-8, 3-24
	3-9, 3-10,	F-Domain.....	3-4
	3-11, 3-12,	FM Deviation.....	3-33
	3-18, 3-20,	Freq. Setting	3-10, 3-11,
	3-22, 3-25,		3-28, 3-30
	3-26, 3-28,	Frequency Input.....	3-13, 3-37
	3-30, 3-32	Gate Position	3-8, 3-24
Cont Auto Level Set	3-13, 3-37	Gate Setup	3-8, 3-23,
Copy from STD	3-4, 3-10,		3-24
	3-11, 3-13,	Gate Source	3-8, 3-24
	3-27, 3-29,	Gate Width.....	3-8, 3-24
	3-30, 3-36	Gated Sweep	3-8, 3-25
Data Length.....	3-13, 3-33,	Gated Sweep ON/OFF.....	3-8, 3-24
	3-34	Graphic FFT of Dmd	3-13, 3-33
DC CAL.....	3-4, 3-13,	Graphic Time-Freq	3-13, 3-33
	3-36	Inband Spurious.....	3-4

3.1 Menu Index

Insert Line	3-5, 3-7, 3-10, 3-11, 3-12, 3-17, 3-22, 3-27, 3-29, 3-30, 3-32	Power.....	3-4
Judgment.....	3-5, 3-6, 3-7, 3-8, 3-9, 3-10, 3-11, 3-12, 3-18, 3-20, 3-22, 3-25, 3-26, 3-29, 3-31, 3-32	Preselector	3-7, 3-12, 3-22, 3-32
Link	3-13, 3-36	Ref Power	3-10, 3-11, 3-28, 3-31
Load Table	3-7, 3-12, 3-22, 3-31, 3-32	Result.....	3-7, 3-10, 3-11, 3-22, 3-28, 3-30
Lower Limit	3-5, 3-8, 3-9, 3-18, 3-26	Rolloff Factor	3-10, 3-29
Margin ΔX ON/OFF	3-10, 3-11, 3-27, 3-29	Save Table	3-7, 3-12, 3-22, 3-32
Marker Edit	3-10, 3-11, 3-27, 3-30	Set to Default.....	3-7, 3-12, 3-23, 3-32
Meas F-Range	3-13, 3-34	Set to STD	3-5, 3-6, 3-8, 3-9, 3-10, 3-11, 3-17, 3-18, 3-20, 3-25, 3-26, 3-29, 3-31
Modulation.....	3-4, 3-33	Shift X	3-5, 3-10, 3-11, 3-17, 3-27, 3-29
Multiplier	3-7, 3-22	Shift Y	3-5, 3-10, 3-11, 3-17, 3-27, 3-29
Numeric Current	3-13, 3-33	Slope.....	3-5, 3-6, 3-7, 3-8, 3-16, 3-19, 3-21, 3-24
OBW	3-4	Sort	3-5, 3-10, 3-11, 3-17, 3-27, 3-30
OBW%.....	3-9, 3-26	Spurious.....	3-4
OFF Position	3-6, 3-20	STD	3-4, 3-36
OFF Width	3-6, 3-20	STD Setup	3-4, 3-13, 3-36
Offset Level	3-13, 3-36	Symbol Rate 1/T.....	3-10, 3-29
ON Position.....	3-6, 3-20	Table Edit	3-7, 3-12, 3-22, 3-32
ON Width.....	3-6, 3-20	Table Init	3-5, 3-7, 3-10, 3-11, 3-12, 3-17, 3-22, 3-27, 3-30, 3-32
ON/OFF Ratio.....	3-4	Table No. 1/2/3.....	3-7, 3-12, 3-21, 3-22, 3-31, 3-32
Outband Spurious	3-4	T-Domain	3-4, 3-15
Parameter Setup	3-5, 3-6, 3-7, 3-8, 3-9, 3-10, 3-11, 3-12, 3-13, 3-18, 3-20, 3-22, 3-25, 3-26, 3-28, 3-30, 3-32, 3-33, 3-34, 3-35	Template.....	3-5, 3-10, 3-11, 3-17,
Peak MKR Y Delta	3-7, 3-11, 3-12, 3-22, 3-30, 3-32		

Template Couple to Power	3-5, 3-10, 3-11, 3-18, 3-28, 3-31	Window Width.....	3-5, 3-8, 3-17, 3-25
Template Edit.....	3-5, 3-10, 3-11, 3-17, 3-27, 3-29	Y Scale [dB/div] 10/5/2	3-5, 3-6, 3-8, 3-17, 3-20, 3-25
Template Limit	3-5, 3-10, 3-11, 3-18, 3-29, 3-31		
Template ON/OFF	3-5, 3-11, 3-17, 3-27, 3-29		
Template UP/LOW	3-5, 3-17		
Time & FFT	3-35		
Time-Freq START/SPAN	3-13, 3-33		
Trigger	3-8, 3-24		
Trigger Delay	3-13, 3-35		
Trigger Level	3-5, 3-6, 3-7, 3-8, 3-13, 3-16, 3-19, 3-24, 3-35		
Trigger Position	3-5, 3-6, 3-7, 3-8, 3-16, 3-19, 3-21, 3-24		
Trigger Setup	3-5, 3-6, 3-7, 3-8, 3-16, 3-19, 3-21, 3-23		
Trigger Slope	3-13, 3-35		
Trigger Source	3-5, 3-6, 3-7, 3-8, 3-13, 3-16, 3-19, 3-21, 3-24, 3-35		
Tx Power.....	3-4, 3-34		
Type	3-13, 3-36		
Upper Limit.....	3-5, 3-6, 3-8, 3-9, 3-18, 3-20, 3-26		
Window ON/OFF	3-5, 3-6, 3-8, 3-17, 3-20, 3-25		
Window Position.....	3-5, 3-8, 3-17, 3-25		
Window Setup.....	3-5, 3-6, 3-8, 3-17, 3-20, 3-25		

3.2 Menu Map

3.2 Menu Map

This section shows the hierarchical menu configuration on a panel key basis.

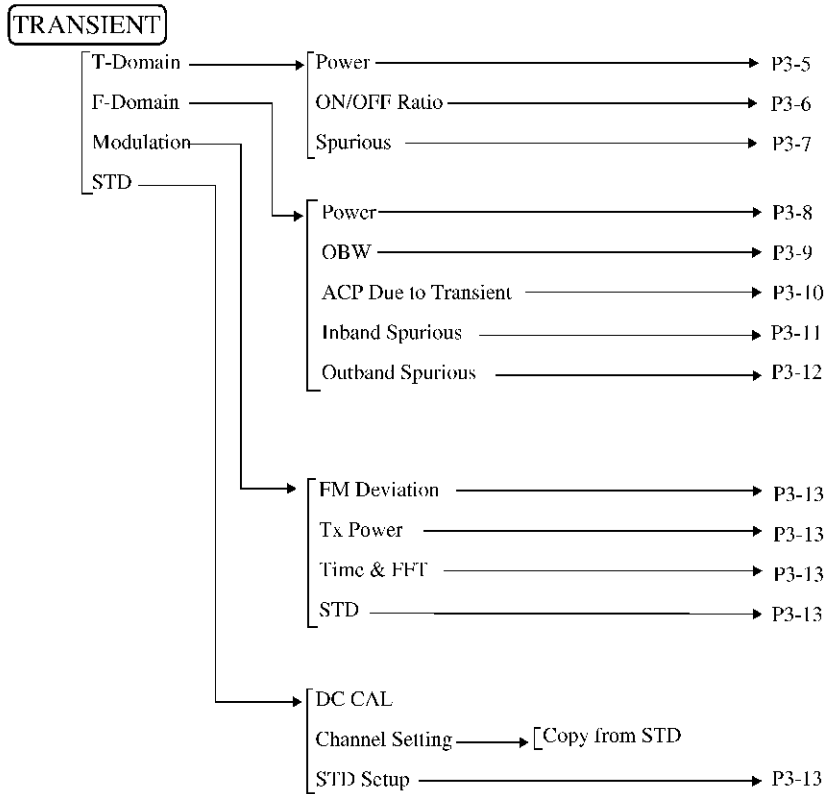

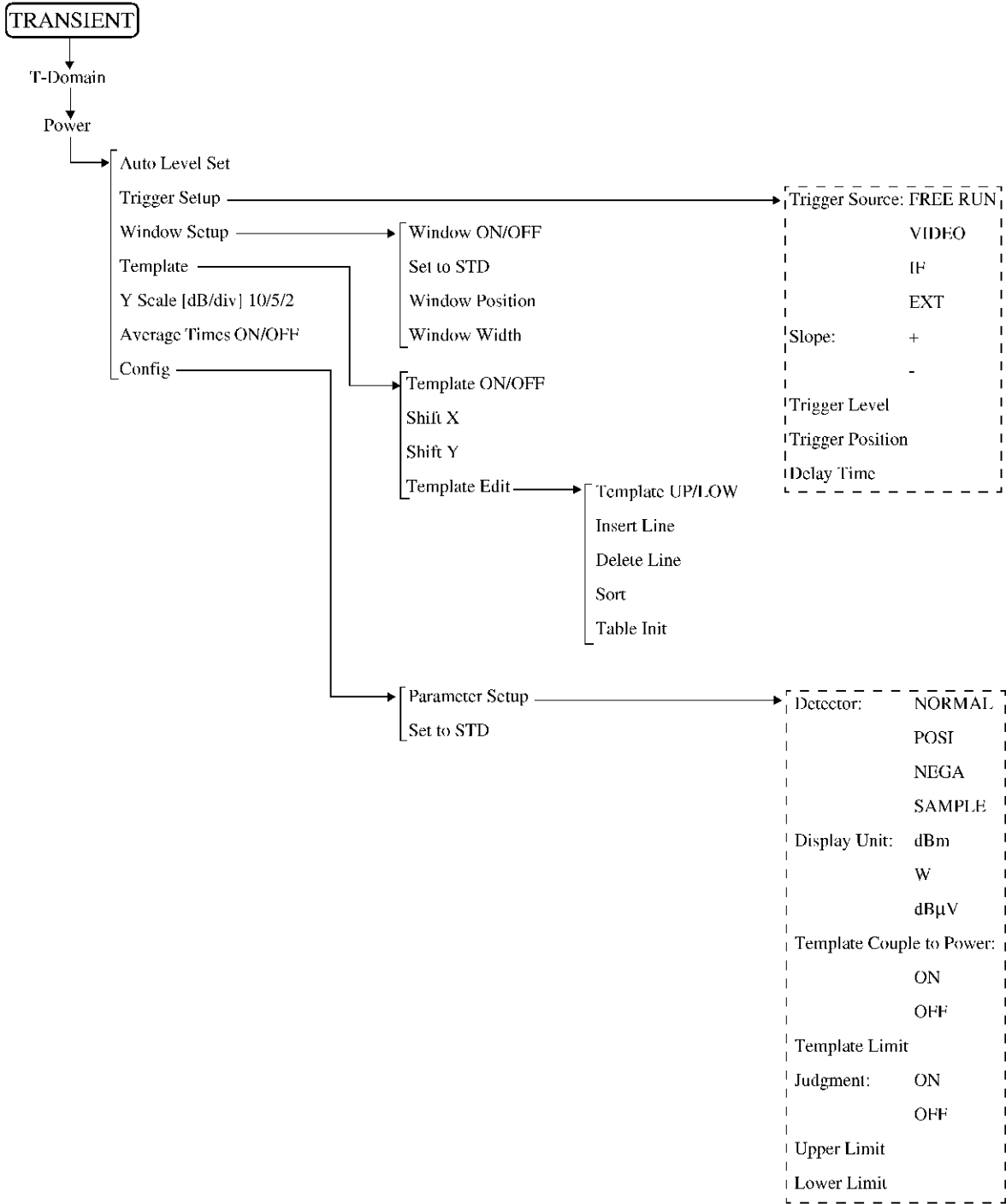

3.2 Menu Map

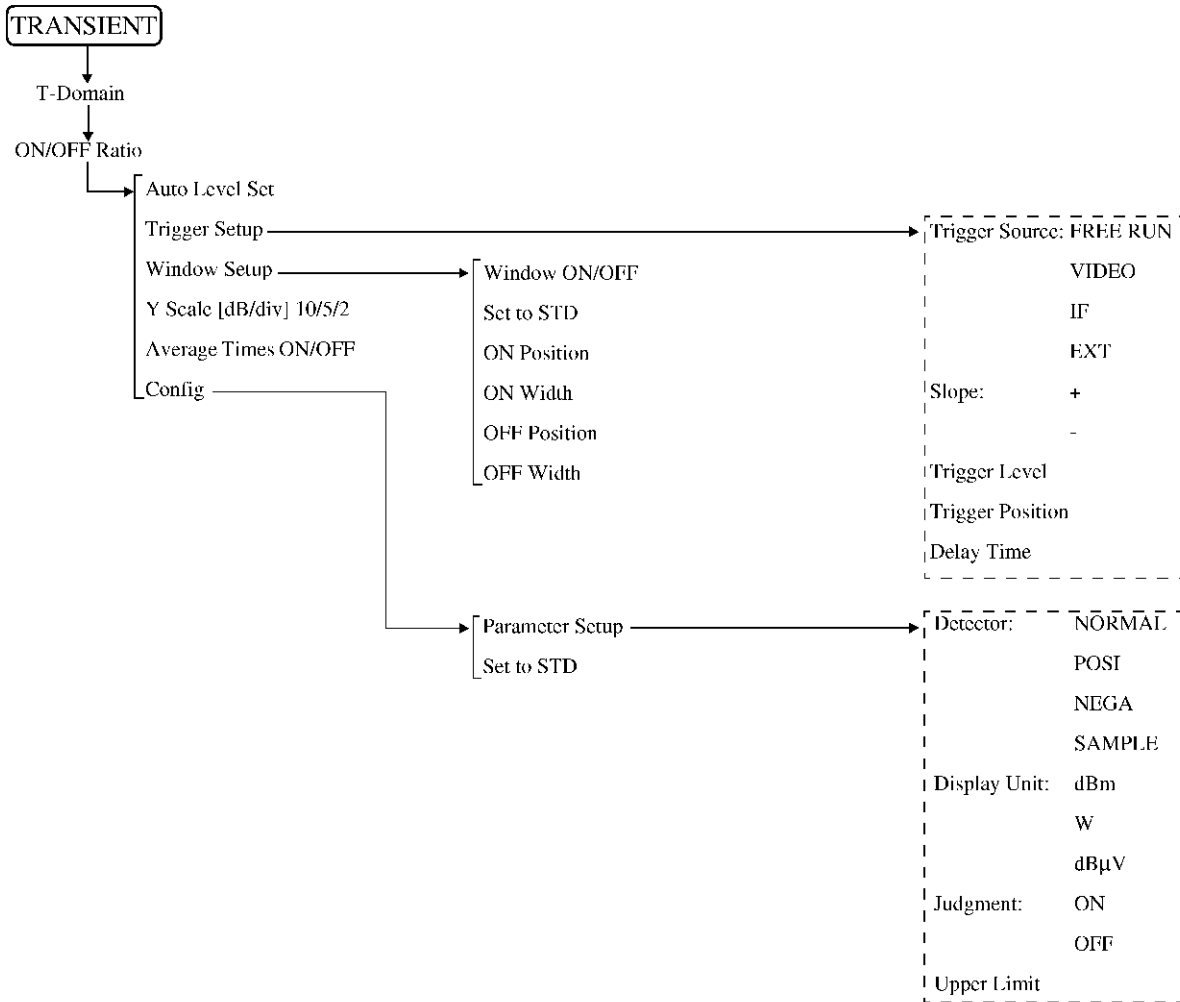

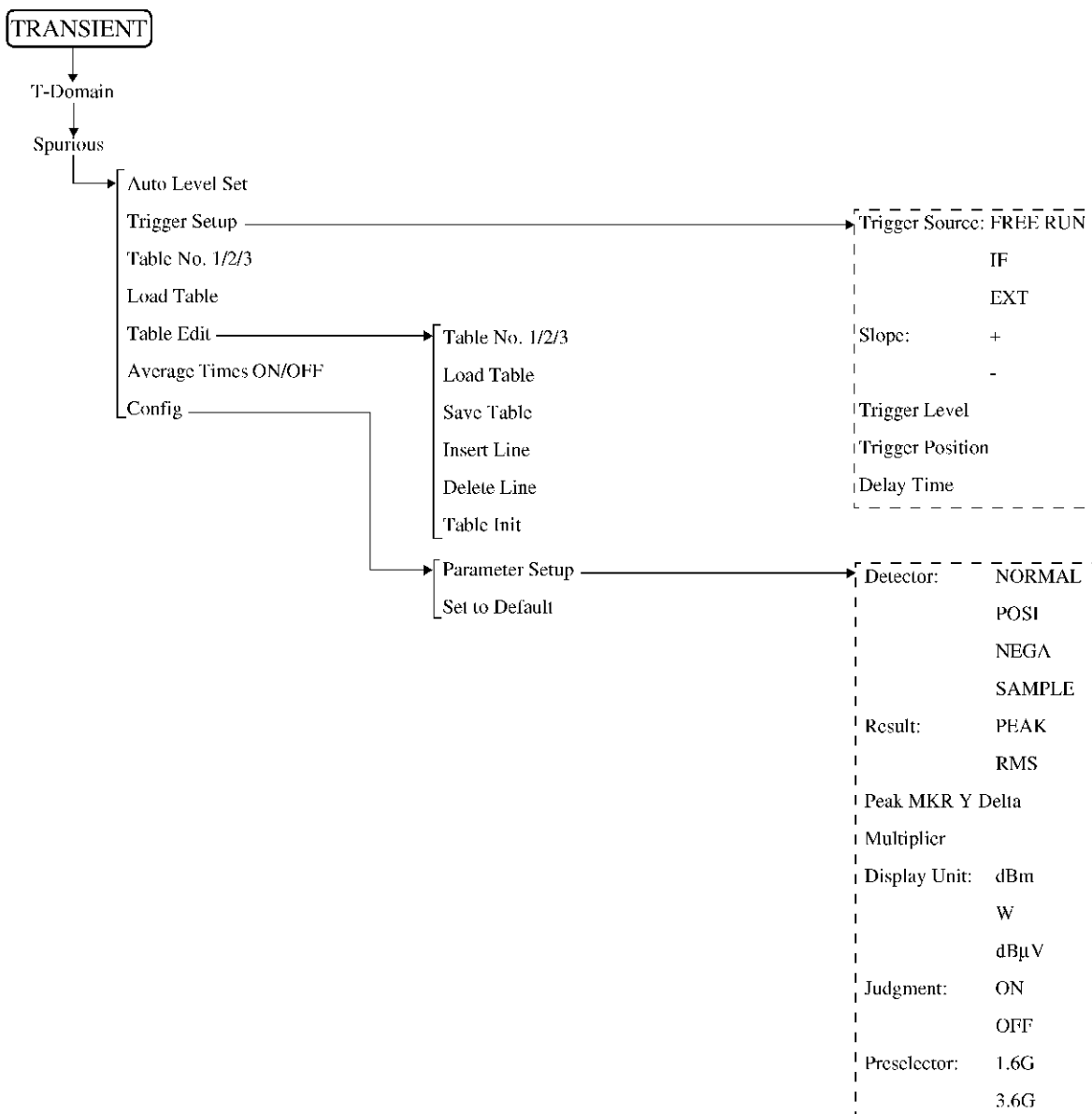

3.2 Menu Map

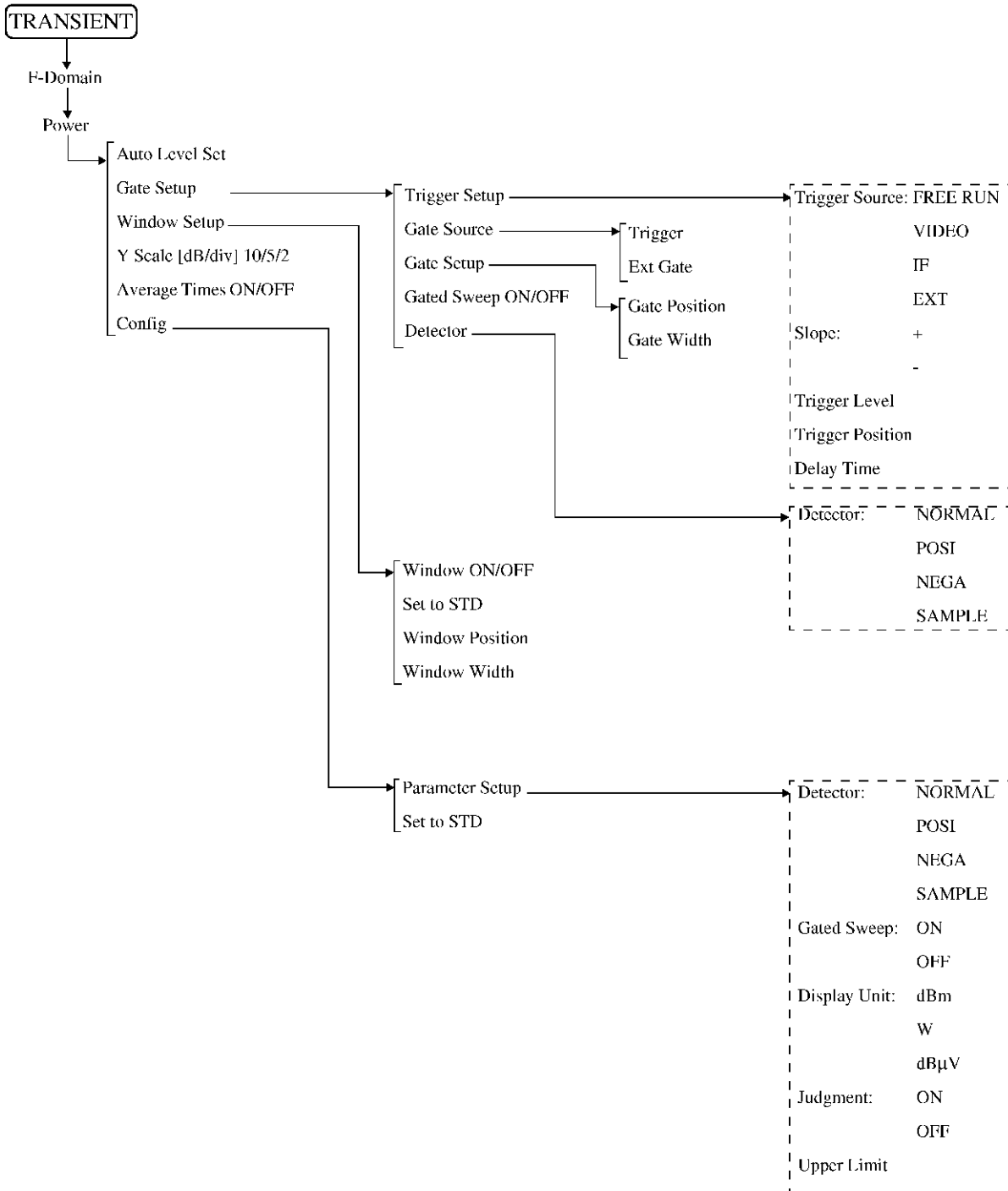

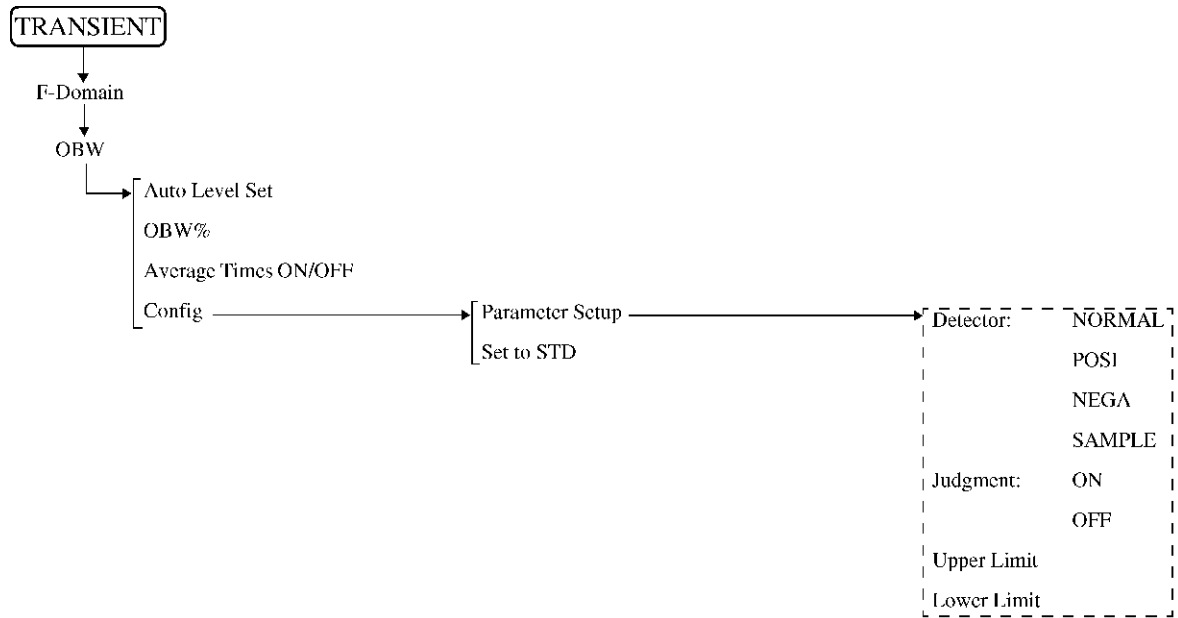

3.2 Menu Map

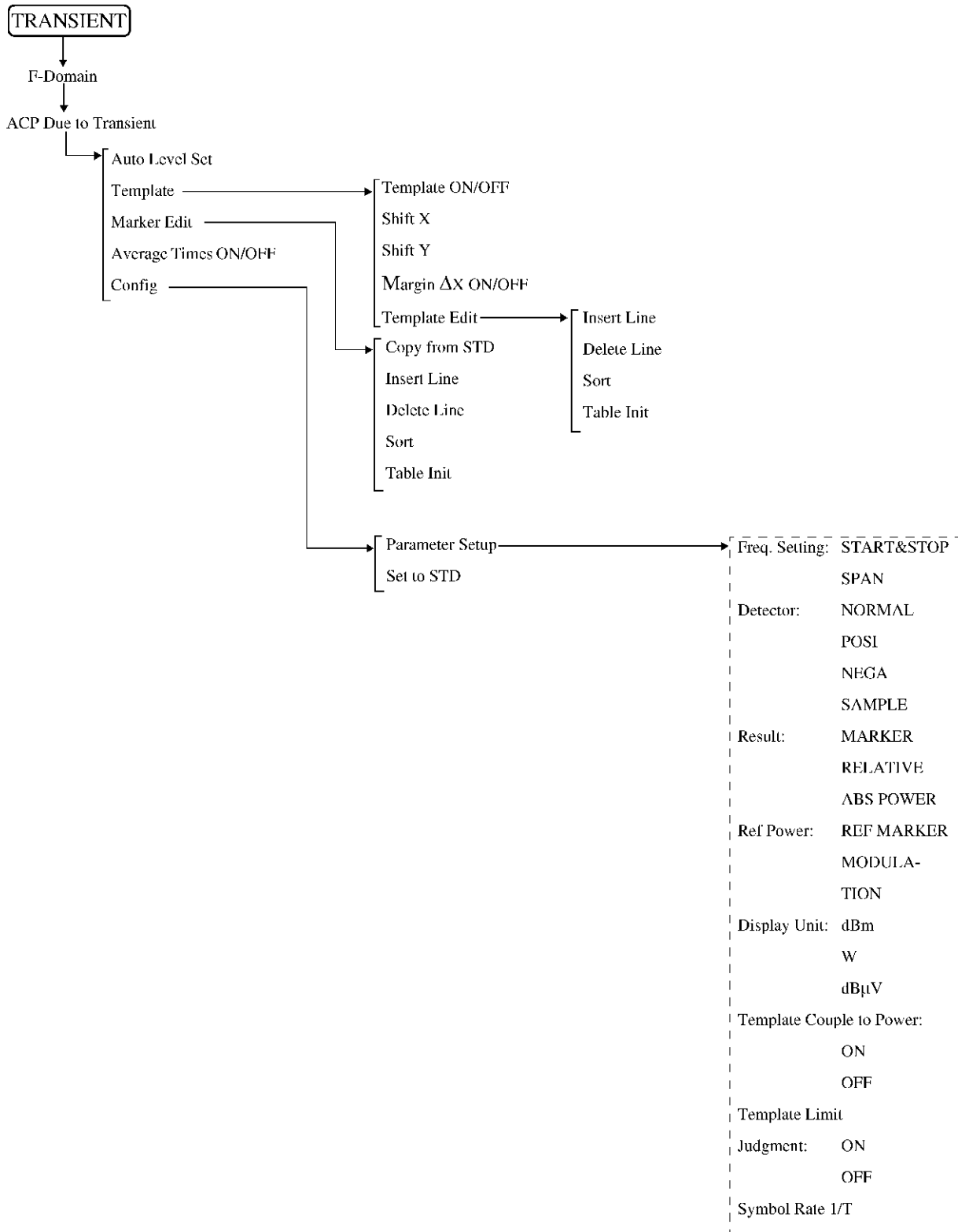

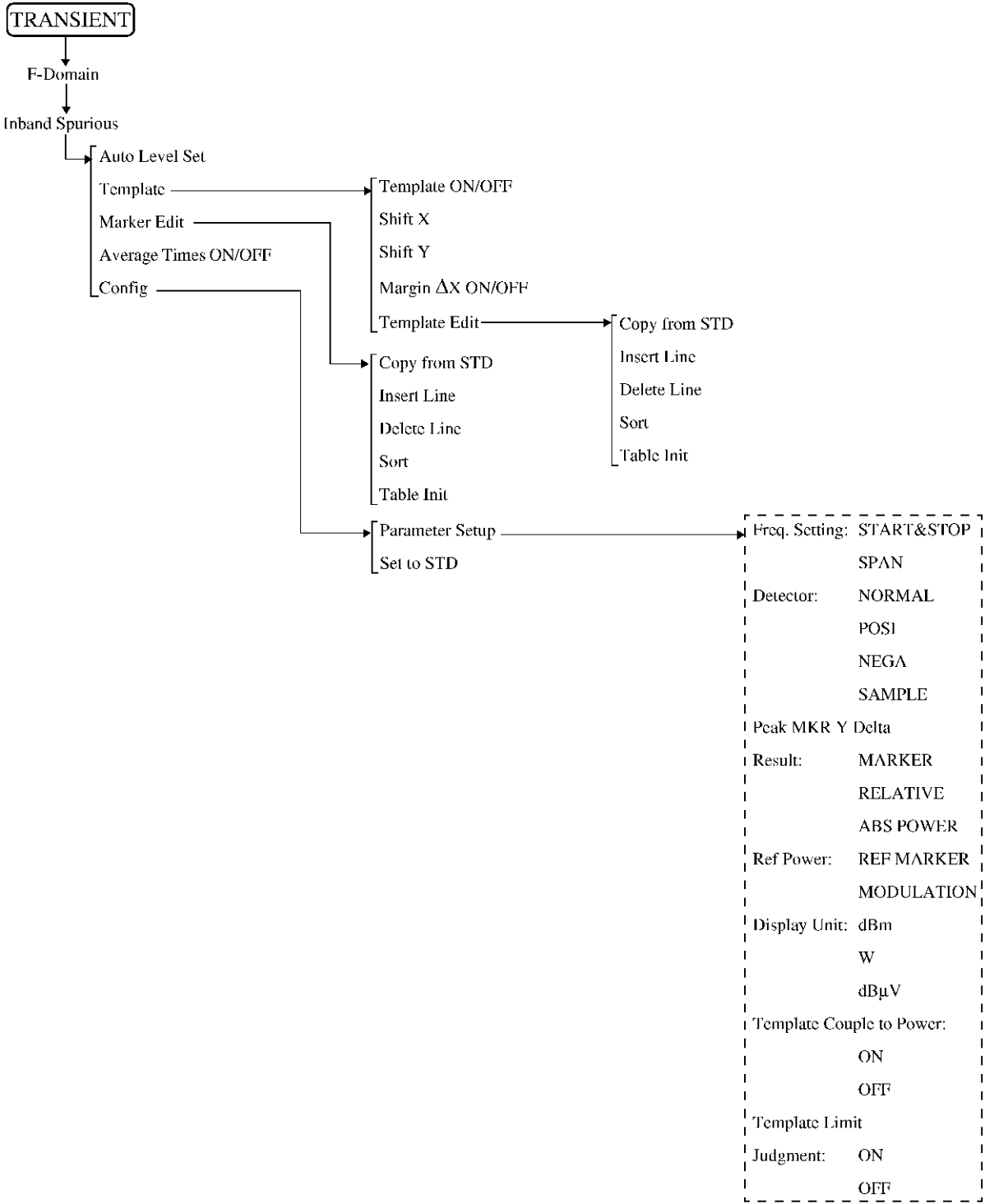

3.2 Menu Map

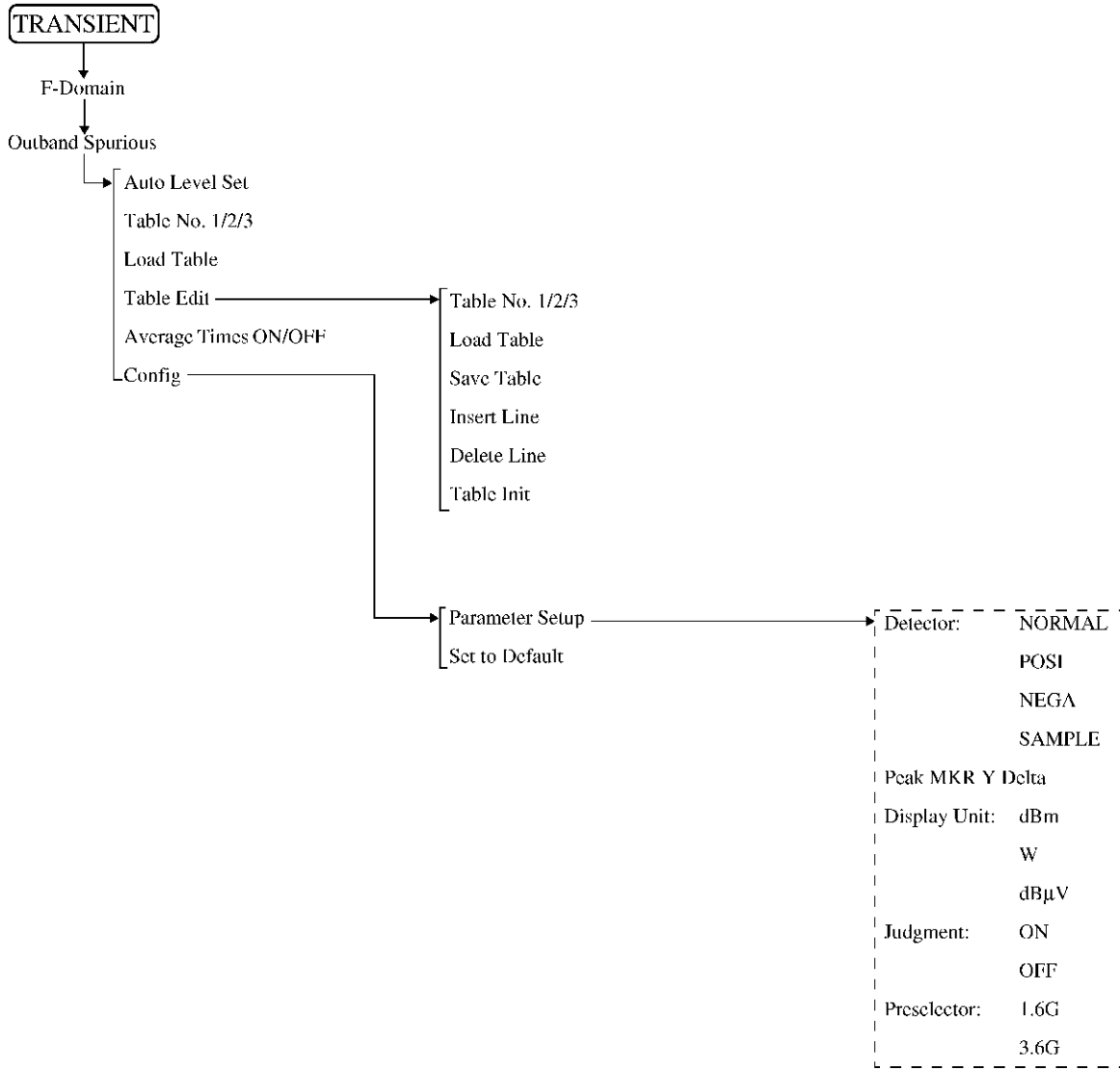

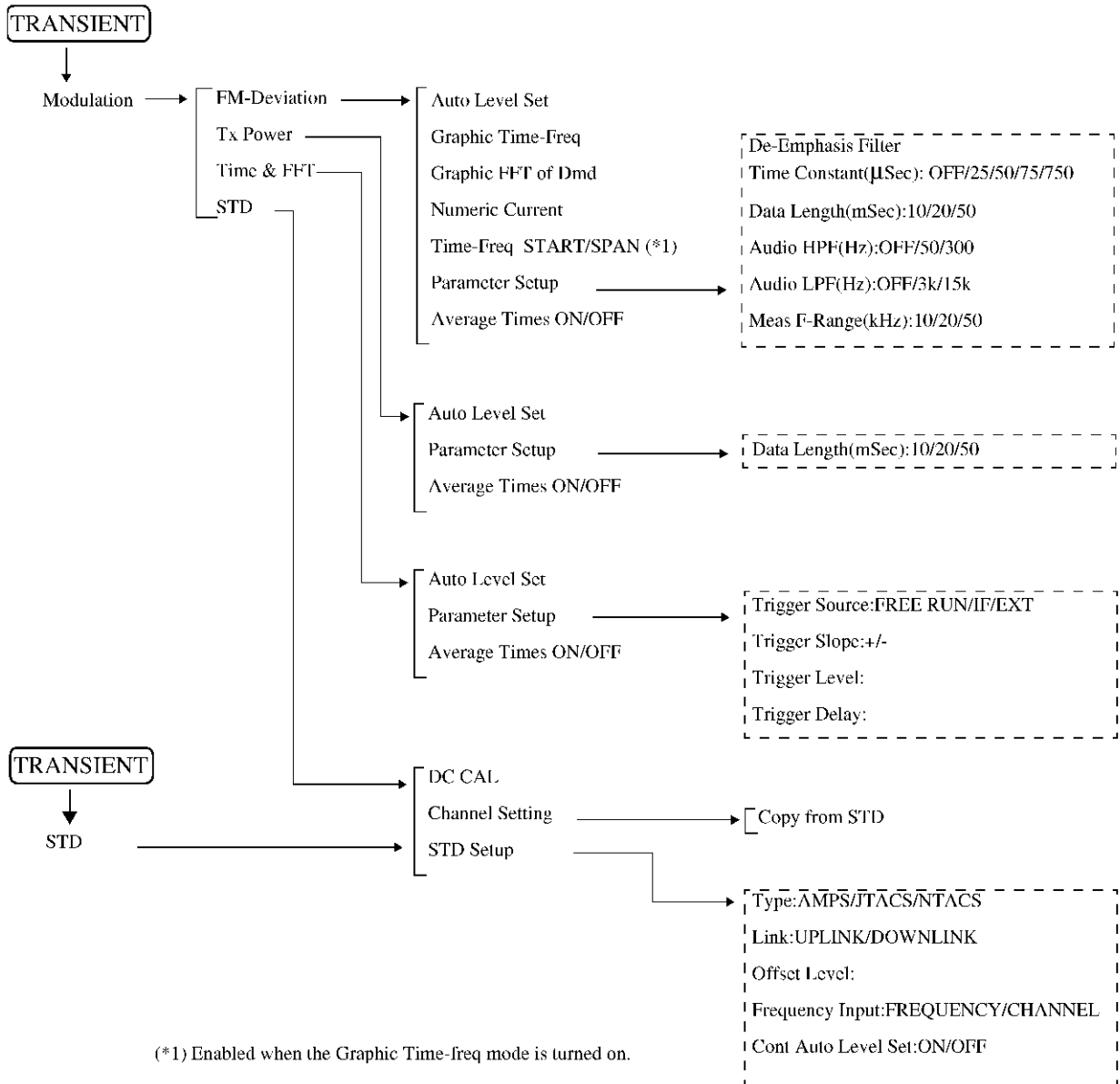

3.3 Functional Description

3.3 Functional Description

When modulation analysis hardware and software are installed, the following menus are assigned to the TRANSIENT key.

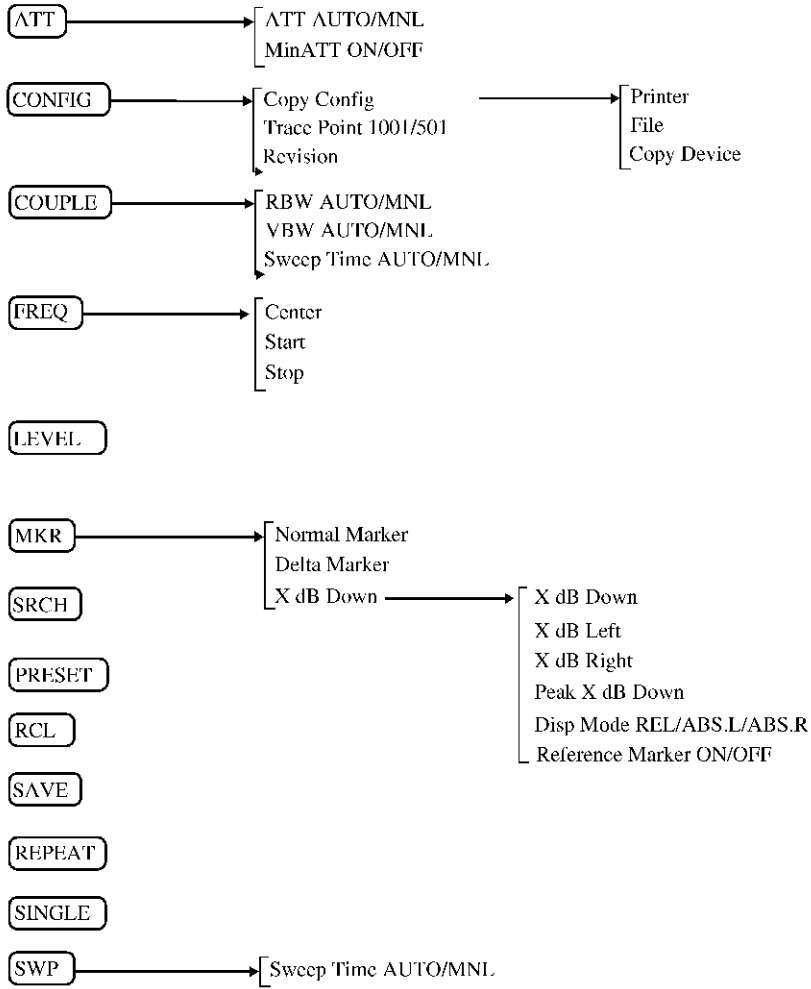

3.3.1 Switching Communication Systems

This section describes how to switch the communication systems. The analyzer must be set to the SPA mode to switch between the communication systems.

NOTE: *After the communication system has been switched, the parameters previously set for the former communication system will be cleared.
If necessary, save the old parameters, before switching the communication system to another.*

1. Press the **POWER** key to enter the SPA mode.
2. Press **CONFIG**.
3. Press *more 1/2*.
If there are other communication systems installed, with which this instrument can analyze, "Comm.System" is displayed in the soft menu.
4. Press *Comm.System*.
Select the communication system you wish using the data knob, and press the knob (or **ENTR**).

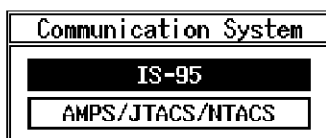

Figure 3-1 Dialog Box Used for the Communication Systems

5. When the data knob (or **ENTR**) is pressed, the message "LOADING" is displayed. After the message disappears, the switchover to another system is complete.
6. Press the **TRANSIENT** key to confirm that the menu has been changed.

Saving set conditions

1. To save the parameters, press **SHIFT** and **RCL**.
2. Set the SAVE FILE number and press **Save**.

3.3.2 T-Domain

Carries out a measurement according to the standard using the zero span of the spectrum analyzer. Measurement items include power, ON/OFF ratio of a burst signal, and spurious measurements in the time domain with a specified frequency.

In the T-Domain measurement, the setting for the RBW, VBW, Sweep Time, or Detector is saved when exiting from each measurement and recalled when entering each measurement again. To return the setting to the value specified by the standard, press *Config* and *Set to STD*.

3.3 Functional Description

3.3.2.1 Power (T-Domain)

This is a function to measure power in the time domain (zero span).

There are two Pass/Fail judgment functions: a judgment function for the template and a judgment function for power.

NOTE: The RBW must be set wider than the modulation band.

Auto Level Set

Sets the internal reference level to an optimum value in accordance with the measurement signal. The reference level is automatically adjusted when this key is pressed.

NOTE: The input signal level must be constant while Auto Level Set is being carried out.

Trigger Setup

Sets a trigger.

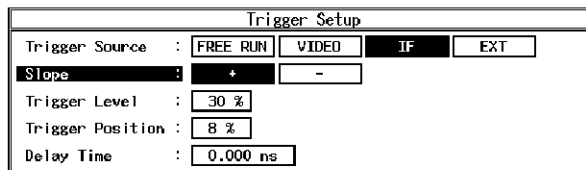

Figure 3-2 Trigger Setup Dialog Box

Trigger Source

Selects a trigger.

FREE RUN:

Captures data using the internal measurement timing.

VIDEO: Captures the signal in sync with the VIDEO signal.

IF: Captures the signal in sync with the IF signal (the leading edge of the burst).

EXT: Captures the signal in sync with the external trigger signal.

Slope

Selects the edge when triggering.

+: Triggers at the leading edge.

-: Triggers at the trailing edge.

Trigger Level

Sets the level to trigger.

Trigger Position

Sets the trigger position where it is displayed on the screen.

Delay Time

Sets a delay time from the time a trigger signal is detected to the time the signal is captured.

NOTE: When Delay Time is a negative value, signals before the trigger can be captured.

Window Setup	Sets the window used for power measurement.
Window ON/OFF	Displays a window showing the range for power measurement. When OFF is set, the power measurement range covers all points on the display screen.
Set to STD	Sets the window specified by the communication standard.
Window Position	Sets the position of the window.
Window Width	Sets the width of the window.

NOTE: When the window is partially outside the display, an arrow is shown next to Posi, Width or both in the area indicating the window conditions.

Template	Sets the template.
Template ON/OFF	Sets whether to display the template and to toggles the Pass/Fail judgment function on or off.
Shift X	Sets the amount of template movement in the X-axis direction.
Shift Y	Sets the amount of template movement in the Y-axis direction.
Template Edit	Edits the template.
Template UP/LOW	Selects the upper template or the lower template.
Insert Line	Inserts a line.
Delete Line	Deletes a line.
Sort	Sorts template data in ascending order.
Table Init	Initializes the table.
Y Scale [dB/div] 10/5/2	Switches the display screen scale to 10, 5 or 2 dB/div.

3.3 Functional Description

Average Times ON/OFF

Sets the averaging count.
Used to perform averaging of both display screen and power at the same time.
(This is because a large error results when calculating power from the averaged display screen, since the display screen is logarithmically compressed.)

Config

Parameter Setup

Sets the method of measurement, edits the template, and so forth.

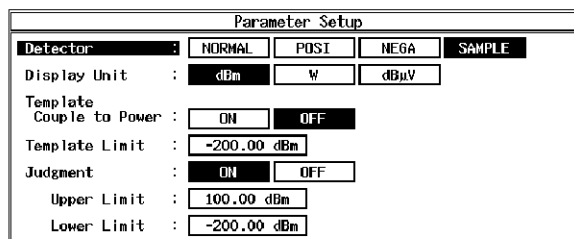

Figure 3-3 Parameter Setup Dialog Box

Detector

NORMAL/POSI/NEGA/SAMPLE
Selects the detector.

Display Unit

dBm/W/dBμV
Sets the display unit of power.

Template Couple to Power

Displays the template that is connected to the measured power.
ON: Displays the template that is connected to the measured power.
On the template edit screen, set the template level to the portion linked with the power value set to 0 dB.
OFF: Displays the template regarding the Y-axis value edited by the template as an absolute value.

Template Limit

If the absolute value of the template is smaller than this value when Template Couple to Power is set to ON, clip the template at this value.

Judgment

Sets ON/OFF for Pass/Fail judgments.

Upper Limit

Sets the upper limit value of power.

Lower Limit

Sets the lower limit value of power.

Set to STD

Returns measurement parameters to the values specified by the communication standard.

3.3.2.2 ON/OFF Ratio

Measures the power during the burst-on period and the one during the burst-off period, and calculate the ratio of the powers.

Captures the signal with a trigger and calculates the ratio in reference to the burst on and burst off periods (the former is defined as the period immediately before the trigger point; the latter, immediately after the trigger point).

Auto Level Set

Sets the internal reference level to an optimum value in accordance with the measurement signal. The reference level is automatically adjusted when this key is pressed.

NOTE: The signal level must remain constant while Auto Level Set is being carried out.

Trigger Setup

Sets a trigger.

Trigger Setup	
Trigger Source :	<input type="radio"/> FREE RUN <input type="radio"/> VIDEO <input checked="" type="radio"/> IF <input type="radio"/> EXT
Slope :	<input checked="" type="radio"/> + <input type="radio"/> -
Trigger Level :	<input type="text" value="30 %"/>
Trigger Position :	<input type="text" value="8 %"/>
Delay Time :	<input type="text" value="0.000 ns"/>

Figure 3-4 Trigger Setup Dialog Box

Trigger Source

Selects a trigger

FREE RUN:

Captures data using the internal measurement timing.

VIDEO: Captures the signal in sync with the VIDEO signal.

IF: Captures the signal in sync with the IF signal (the leading edge of the burst).

EXT: Captures the signal in sync with the external trigger signal.

Slope

Selects the edge when triggering.

+: Triggers at the leading edge.

-: Triggers at the trailing edge.

Trigger Level

Sets the level to trigger.

Trigger Position

Sets where the trigger position is displayed on the screen.

Delay Time

Sets a delay time from the time a trigger signal is detected to the time the signal is captured.

NOTE: When Delay Time is a negative value, signals before the trigger can be captured.

3.3 Functional Description

Window Setup	Sets the burst ON and OFF periods.
Window ON/OFF	Displays a window showing the range for power measurement.
Set to STD	Sets the value that is specified by or complies with the communication standard.
ON Position	Sets the desired position during the burst-on period.
ON Width	Sets the desired width during the burst-on period.
OFF Position	Sets the position during the burst-off period.
OFF Width	Sets the width during the burst-off period.

NOTE: When the window is partially outside the display, an arrow is shown next to Posi, Width or both in the area indicating the window conditions.

Y Scale [dB/div] 10/5/2	Selects the display screen scale to 10, 5 or 2 dB/div.
Average Times ON/OFF	Sets the averaging count.

Config

Parameter Setup Sets measurement conditions.

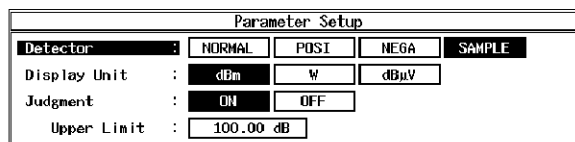

Figure 3-5 Parameter Setup Dialog Box

Detector	NORMAL/POSI/NEGA/SAMPLE Selects the detector.
Display Unit	dBm/W/dBμV Sets the display unit of power.

NOTE: The ON/OFF ratio is displayed in units of dB (fixed).

Judgment	Sets ON/OFF of the Pass/Fail judgment for the ON/OFF ratio.
Upper Limit	Enters the upper limit value.

Set to STD Sets measurement parameters to the values specified by the communication standard.

3.3.2.3 Spurious (T-Domain)

This is a function to measure power (or peak power) according to the frequency specified in the table by sweeping in the zero span mode.

Auto Level Set

Sets the internal reference level to an optimum value in accordance with the measurement signal. The reference level is automatically adjusted when this key is pressed.

NOTE: The signal level must be constant while Auto Level Set is being carried out.

Trigger Setup

Sets a trigger.

Trigger Setup	
Trigger Source :	FREE RUN VIDEO IF EXT
Slope :	+ -
Trigger Level :	30 %
Trigger Position :	0 %
Delay Time :	0.000 ns

Figure 3-6 Trigger Setup Dialog Box

Trigger Source

Selects a trigger

FREE RUN:

Captures data using the internal measurement timing.

IF: Captures the signal in sync with the IF signal (the leading edge of the burst).

EXT: Captures the signal in sync with the external trigger signal.

Slope

Selects the edge when triggering.

+: Triggers at the leading edge.

-: Triggers at the trailing edge.

Trigger Level

Sets the level to trigger.

Trigger Position

Sets where the trigger position is displayed on the screen.

Delay Time

Sets a delay time from the time a trigger signal is detected to the time the signal is captured.

NOTE: When Delay Time is a negative value, signals before the trigger can be captured.

Table No. 1/2/3

Selects the measurement table.

3.3 Functional Description

<i>Load Table</i>	Loads the measurement table.
<i>Table Edit</i>	Edits the measurement table.
<i>Table No. 1/2/3</i>	Selects the table to be edited.
<i>Load Table</i>	Loads the measurement table.
<i>Save Table</i>	Saves the measurement table.
<i>Insert Line</i>	Inserts additional frequency data before the selected frequency number.
<i>Delete Line</i>	Deletes the selected line.
<i>Table Init</i>	Initializes the table
<i>Average Times ON/OFF</i>	Sets the averaging count. Max Hold is set when the detector is set to POSI.

Config

Parameter Setup Sets measurement conditions.

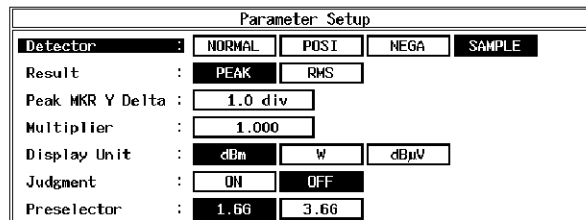

Figure 3-7 Parameter Setup Dialog Box

<i>Detector</i>	NORMAL/POSI/NEGA/SAMPLE Selects the detector.
<i>Result</i>	PEAK/RMS Sets whether to display the result using average power or peak power.
<i>Peak MKR Y Delta</i>	Sets the Y delta of the peak marker.
<i>Multiplier</i>	Multiplies the measurement result by the set value, then displays the resultant value.
<i>Display Unit</i>	dBm/W/dBμV Sets the display units.
<i>Judgment</i>	Sets ON/OFF of the Pass/Fail judgment for the limit value.
<i>Preselector</i>	Sets the preselector.

NOTE: This menu is displayed on R3267 only.

1.6G: Used to measure harmonics of more than 1.6 GHz or spurious signals when the carrier frequency is lower than 1.6 GHz.

3.6G: Used to set this parameter for cases other than that above.

Set to Default

Returns the set value to the default.

3.3.3 F-Domain

Carries out a measurement according to the communication standard using the spectrum analyzer's sweep measurement method. Measurement items include power, occupied bandwidth, ACP Due To Transient, Inband Spurious, and Outband Spurious measurements in the frequency domain.

In F-Domain measurement, the setting for the RBW, VBW, Sweep Time, or Detector is saved when exiting each measurement and recalled when entering each measurement again. To return the setting to the value specified by the standard, press *Config* and *Set to STD*.

3.3.3.1 Power (F-Domain)

This is a function to measure power in the frequency domain using the spectrum analyzer.

Auto Level Set

Sets the internal reference level to an optimum value in accordance with the measurement signal. The reference level is automatically adjusted when this key is pressed.

NOTE: The signal level must be constant while Auto Level Set is being carried out.

Gate Setup

Sets the gated sweep.

This setting is required when the input signal is a bursted signal and Sample Detector is used.

Trigger Setup

Sets a trigger.

Trigger Setup	
Trigger Source :	FREE RUN VIDE0 IF EXT
Slope :	+ -
Trigger Level :	30 %
Trigger Position :	8 %
Delay Time :	0.000 ns

Figure 3-8 Trigger Setup Dialog Box

3.3 Functional Description

Trigger Source	Selects a trigger FREE RUN: Captures data using the internal measurement timing. VIDEO: Captures the signal in sync with the VIDEO signal. IF: Captures the signal in sync with the IF signal (the leading edge of the burst). EXT: Captures the signal in sync with the external trigger signal.
Slope	Selects the edge when triggering. +: Triggers at the leading edge. -: Triggers at the trailing edge.
Trigger Level	Sets the level to trigger.
Trigger Position	Sets where the trigger position is displayed on the screen.
Delay Time	Sets a delay time from the time a trigger signal is detected to the time the signal is captured.

NOTE: When Delay Time is a negative value, signals before the trigger can be captured.

Gate Source

Trigger Sets Trigger Source specified by Trigger Setup as Gate Source.

NOTE: When Trigger Source is set to IF and SPAN is set to a frequency higher than 6 MHz, the sweeping seems to be stopped, because the IF trigger bandwidth is approximately 6 MHz and the gate trigger is failing.

Ext Gate Sets the gated sweep mode using the gate signal input from the EXT GATE terminal on the rear panel.

Gate Setup Sets the gated sweep range when Trigger is selected for Gate Source.

Gate Position Sets the gate position.

Gate Width Sets the gate width.

Gated Sweep ON/OFF Starts the gated sweep.

Detector NORMAL/POST/NEGA/SAMPLE
Selects the detector.

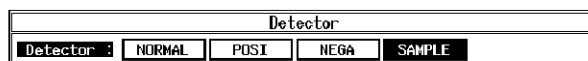

Figure 3-9 Detector Dialog Box

Window Setup Sets the frequency range used for power measurement.

Window ON/OFF Sets the window to ON or OFF. When the window is set to OFF, the power measurement range becomes a sweep band.

Set to STD Sets the value determined by the communication standard.

Window Position Sets the position of the window.

Window Width Sets the width of the window.

NOTE: When the window is partially outside the display, an arrow is shown next to Posi, Width or both in the area indicating the window conditions.

Y Scale [dB/div] 10/5/2 Sets the display scale.

Average Times ON/OFF Sets the averaging count.

Config

Parameter Setup Sets measurement conditions.

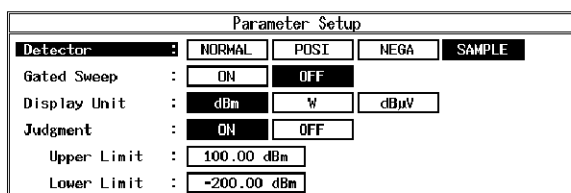

Figure 3-10 Parameter Setup Dialog Box

Detector NORMAL/POST/NEGA/SAMPLE
Selects the detector.

Gated Sweep Sets the gated sweep to ON or OFF.

Display Unit dBm/W/dBµV Selects the display unit.

Judgment Sets ON/OFF of the Pass/Fail judgment for measured power.

3.3 Functional Description

Upper Limit

Sets the upper limit for Pass/Fail judgment.

Set to STD

Sets the measurement parameters to the values specified by the communication standard.

3.3.3.2 OBW

Measure an occupied bandwidth.

Auto Level Set

Sets the internal reference level to an optimum value in accordance with the measurement signal. The reference level is automatically adjusted when this key is pressed.

NOTE: The signal level must be constant while Auto Level Set is being carried out.

OBW%

Sets the frequency, including the percentage of the total power as an occupied bandwidth, when calculating the occupied bandwidth.

Average Times ON/OFF

Sets the averaging count.

Config

Parameter Setup

Sets measurement conditions.

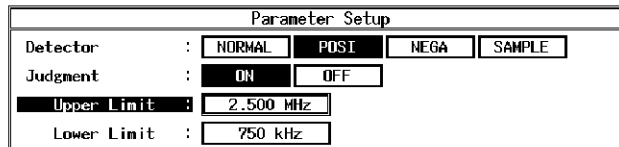

Figure 3-11 Parameter Setup Dialog Box

Detector

NORMAL/POSI/NEGA/SAMPLE
Selects the detector.

Judgment

Sets ON/OFF of the Pass/Fail judgment for the occupied bandwidth.

Upper Limit

Sets the upper limit for Pass/Fail judgment.

Lower Limit

Sets the lower limit for Pass/Fail judgment.

Set to STD

Sets the measurement parameters to the values specified by the communication standard.

3.3.3.3 ACP Due to Transient

This is a function to measure the spectrum, including the rise and fall times of the burst.

Auto Level Set Sets the internal reference level to an optimum value in accordance with the measurement signal. The reference level is automatically adjusted when this key is pressed.

NOTE: The signal level must be constant while Auto Level Set is being carried out.

Template Sets and edits the template.

Template ON/OFF Sets ON/OFF of the template display. When Template is set to ON, the Pass/Fail judgment for the template is displayed under the sweep screen.

Shift X Shifts the set template in the frequency direction (X-axis).

Shift Y Shifts the set template in the level direction (Y-axis).

Margin ΔX ON/OFF Magnifies the template in the X-axis direction with a set template frequency 0 as the center.

Template Edit Opens the template edit menu.

Insert Line Inserts a line before the selected line.

Delete Line Deletes the selected line.

Sort Sorts the tables in order of frequency.

Table Init Initializes the table.

Marker Edit Sets the measurement frequency (frequency offset) and measurement band.

Copy from STD Sets to the parameters specified by the communication standard.

Insert Line Inserts a line before the selected line.

Delete Line Deletes the selected line.

Sort Sorts data in order of frequency.

Table Init Initializes the table.

Average Times ON/OFF Sets the averaging count.

3.3 Functional Description

Config

Parameter Setup

Sets the method of measurement, edits the template, and so on.

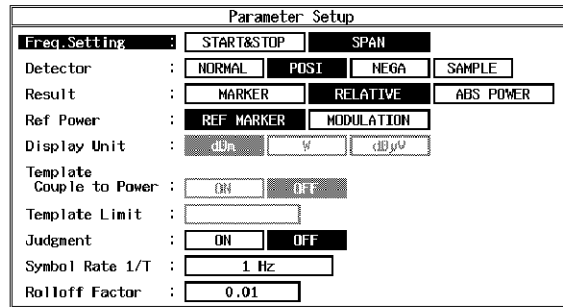

Figure 3-12 Parameter Setup Dialog Box

<i>Freq. Setting</i>	START&STOP/SPAN Selects the measurement mode.
<i>Detector</i>	NORMAL/POSTI/NEGA/SAMPLE Selects the detector.
<i>Result</i>	Specifies how to display the result. MARKER: Displays the marker read value. The position of the marker is set by Marker Edit. RELATIVE: Displays the marker read value using a relative value. ABS POWER: Converts the value displayed by RELATIVE into the absolute value using carrier power and displays it.
<i>Ref Power</i>	When RELATIVE is selected for Result, this selects which relative value to use to display the marker read value. REF MARKER: Displays a relative value to Ref Marker set by Marker Edit. MODULATION: Displays a relative value to the measurement result of Tx power in Modulation.
<i>Display Unit</i>	dBm/W/dBµV Specifies the unit of the result displayed.

NOTE: When RELATIVE is selected for Result, the unit is dB.

Template Couple to Power
Sets whether to raise or lower the template with the power set by Ref Power.

Template Limit	If the absolute value of the template is smaller than this value when Template Couple to Power is set to ON, clip the template at this value.
Judgment	Used to make the Pass/fail judgment for the limit value set by Marker edit. The Pass/Fail judgment result is displayed under the display screen together with the marker list.
Symbol Rate 1/T	Sets the symbol rate of the Root Nyquist filter.
Rolloff Factor	Sets the rolloff of the Root Nyquist filter.

Set to STD Returns the measurement parameters to the values specified by the standard.

3.3.3.4 Inband Spurious

This is a function to search for a peak by sweeping the set frequency.

Auto Level Set Sets the internal reference level to an optimum value in accordance with the measurement signal. The reference level is automatically adjusted when this key is pressed.

NOTE: The signal level must be constant while Auto Level Set is being carried out.

Template

Template ON/OFF	Sets the template display to ON or OFF. When Template is set to ON, the Pass/Fail judgment for the template is displayed under the sweep screen.
Shift X	Shifts the set template in the frequency direction (X-axis).
Shift Y	Shifts the set template in the level direction (Y-axis).
Margin ΔX ON/OFF	Magnifies the template in the X-axis direction with a set template frequency 0 as the center.
Template Edit	
Copy from STD	Copies the template specified by the communication standard.
Insert Line	Inserts a line before the selected line.
Delete Line	Deletes the selected line.

3.3 Functional Description

Sort Sorts the tables in frequency order.

Table Init Initializes the table.

Marker Edit

Copy from STD Sets the measurement parameters specified by the communication standard.

Insert Line Inserts a line before the selected line.

Delete Line Deletes the selected line.

Sort Sorts data in order of frequency.

Table Init Initializes the table.

Average Times ON/OFF Sets the averaging count.

Config

Parameter Setup Sets the method of measurement, edits the template, and so on.

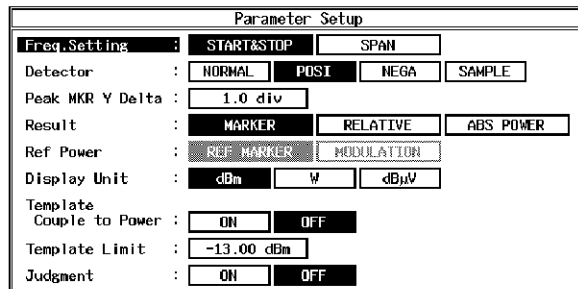

Figure 3-13 Parameter Setup Dialog Box

Freq. Setting START&STOP/SPAN
Selects the measurement mode.

Detector NORMAL/POSTI/NEGA/SAMPLE
Selects the detector.

Peak MKR Y Delta
Sets the Y delta of the peak marker.

Result Specifies how to display the results.

MARKER:
Displays the marker read value. The position of the marker is set by Marker Edit.

RELATIVE:
Displays the marker read value using a relative value.

	<p>ABS POWER: Converts the value displayed by RELATIVE into the absolute value using carrier power and displays it.</p>
Ref Power	<p>When RELATIVE is selected for Result, this selects which relative value is used to display the marker read value.</p> <p>REF MARKER: Displays a relative value to Ref Marker set by Marker Edit.</p> <p>MODULATION: Displays a relative value to the measurement result of Tx power in Modulation.</p>
Display Unit	dBm/W/dB μ V Selects the display unit.

NOTE: When RELATIVE is selected for Result, the unit is dB.

Template Couple to Power	Sets whether or not to raise or lower the template with the power set by Ref Power.
Template Limit	If the absolute value of the template is smaller than this value when Template Couple to Power is set to ON, clip the template at this value.
Judgment	Used to make the Pass/Fail judgment for the limit value set by Marker edit. The Pass/Fail judgment result is displayed under the display screen together with the marker list.
Set to STD	Returns the measurement parameters to the values specified by the standard.

3.3.3.5 Outband Spurious

This is a function to search for a peak by sweeping the frequency according to the table.

Auto Level Set	Sets the internal reference level to an optimum value in accordance with the measurement signal. The reference level is automatically adjusted when this key is pressed.
-----------------------	--

NOTE: The signal level must be constant while Auto Level Set is being carried out.

Table No. 1/2/3	Selects the table number.
Load Table	Loads the table.

3.3 Functional Description

Table Edit	Edits the table.
Table No. 1/2/3	Selects the table number.
Load Table	Loads the table.
Save Table	Saves the table.
Insert Line	Inserts a line before the selected line.
Delete Line	Deletes the selected line.
Table Init	Initializes the table
Average Times ON/OFF	Sets the averaging count

Config

Parameter Setup Sets measurement conditions.

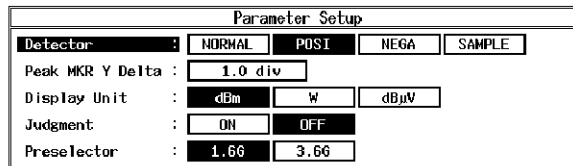

Figure 3-14 Parameter Setup Dialog Box

Detector	NORMAL/POSI/NEGA/SAMPLE Selects the detector.
Peak MKR Y Delta	Sets the Y delta of a peak marker.
Display Unit	dBm/W/dBµV Sets the display unit.
Judgment	Makes the Pass/Fail judgment using the limit values set by Table Edit.
Preselector	Sets the preselector.

NOTE: This menu is displayed on R3267 only.

- 1.6G: Used to measure harmonics of more than 1.6 GHz or spurious signals when the carrier frequency is lower than 1.6 GHz.
- 3.6G: Used to set this parameter for cases other than that above.

Set to Default Returns the set value to the default.

3.3.4 Modulation

Modulation analysis and power measurement are performed using the DSP.

3.3.4.1 FM Deviation

Measure the frequency deviation of FM signals and the distortion of demodulated signals.

Auto Level Set

Sets the internal reference level to an optimum value in accordance with the measurement signal. The reference level is automatically adjusted when this key is pressed.

NOTE: *The signal level must remain constant while Auto Level is being set.*

Graphic Time-Freq

Displays the FM demodulated signal on a graph with frequency on the vertical axis and time on the horizontal axis.

The FM Deviation is obtained from the peak of this data.

The start time and the span of the displayed data is set by "Time-Freq START/SPAN".

Graphic FFT of Dmd

Displays the FFT of the FM demodulated signal.

SINAD, THD and THD+N are calculated from the harmonics element of this data.

Numeric Current

Displays the FM Deviation and Distortion in numerals.

Time-Freq START/SPAN

Sets the display start point and the span of the time waveform (Graphic Time-Freq) of the demodulation data.

Parameter Setup

Sets measurement conditions.

Parameter Setup				
De-Emphasis Filter				
Time Constant(μ Sec) :	OFF	25	50	75 750
Data Length(mSec) :	10	20	50	
Audio HPF(Hz) :	OFF	50	300	
Audio LPF(Hz) :	OFF	3k	15k	
Meas F-Range(kHz) :	10	20	50	

Figure 3-15 Parameter Dialog Box

De-Emphasis Filter Time Constant (μ Sec)

Sets the time constant of De-Emphasis Filter. De-Emphasis Filter consists of the primary CR filter. The value displayed in this menu is the product of C (capacity) and R (resistance).

Data Length (mSec)

Sets the time length of the data for the measurement.

The resolution used to calculate the "Distortion"(frequency resolution of FFT of Dmd) depends on this time length.

3.3 Functional Description

<i>Audio HPF (Hz)</i>	Sets the high-pass filter which restricts the frequency band of the FM demodulated signal noise.
<i>Audio LPF (Hz)</i>	Sets the low-pass filter which restricts the frequency band of the FM demodulated signal noise.
<i>Meas F-Range (kHz)</i>	Sets the measurement frequency range.
<i>Average Times ON/OFF</i>	Sets the averaging count.

3.3.4.2 Tx Power

Measure transmit power.

<i>Auto Level Set</i>	Sets the internal reference level to an optimum value in accordance with the measurement signal. The reference level is automatically adjusted when this key is pressed.
-----------------------	--

NOTE: The signal level must remain constant while Auto Level is being set.

<i>Parameter Setup</i>	Sets measurement conditions.
------------------------	------------------------------



Figure 3-16 Parameter Setup Dialog Box

<i>Data Length (mSec)</i>	Sets the time period of the data for the measurement.
<i>Average Times ON/OFF</i>	Sets the averaging count.

3.3.4.3 Time & FFT

Displays an IF waveform in the time domain or in the FFT waveform.

Auto Level Set

Sets the internal reference level to an optimum value in accordance with the measurement signal. The reference level is automatically adjusted when this key is pressed.

NOTE: *The signal level must remain constant while Auto Level is being set.*

Parameter Setup

Sets measurement conditions.

Parameter Setup	
Trigger Source :	<input type="button" value="FREE RUN"/> <input type="button" value="IF"/> <input type="button" value="EXT"/>
Trigger Slope :	<input type="button" value="+"/> <input type="button" value="-"/>
Trigger Level :	<input type="text"/>
Trigger Delay :	<input type="text" value="0.0 ms"/>

Figure 3-17 Parameter Setup Dialog Box

Trigger Source

Sets the trigger signal.

FREE RUN: Captures data using the internal measurement timing.

IF: Captures the signal in sync with the IF signal (the leading edge of the burst).

EXT: Captures the signal in sync with the external trigger signal.

NOTE: *The external trigger signal is input to the EXT TRIG connector on the rear panel.*

Trigger Slope

Selects the polarity (leading or trailing edge) of a trigger signal.

Trigger Level

Sets the trigger level for the IF trigger.

Trigger Delay

Sets the delay time from the time a trigger signal is detected to the time the signal is captured.

Average Times ON/OFF

Sets the averaging count.

3.3 Functional Description

3.3.5 STD

Sets parameters used for measurement and relationship between the channel number and frequency.

3.3.5.1 DC CAL

Compensates for direct current components inside the circuit.

3.3.5.2 Channel Setting

Sets the relationship between the channel number and frequency.

Copy from STD

Sets the relationship between the channel number and frequency specified by the communication standard. Sets the relationship between the channel number and frequency in the band specified by Type of STD Setup.

3.3.5.3 STD Setup

Opens the STD Setup menu.

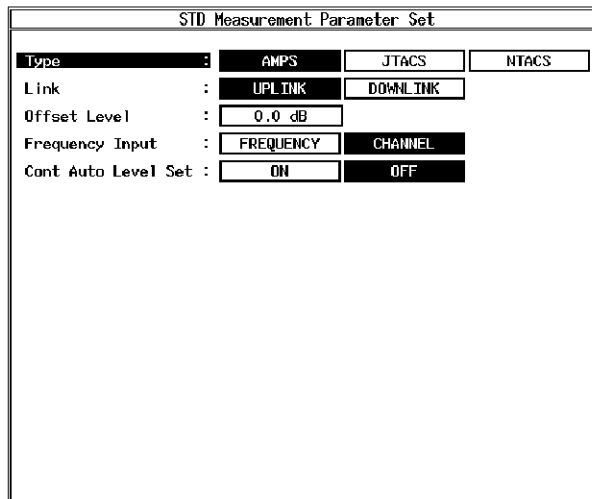

Figure 3-18 STD Measurement Parameter Set Dialog Box

Type

Selects the communication standard. The channel number and the spurious measurement range which are specified for the default template are displayed.

Link

Sets the direction of signal.

UPLINK: Measures signals from the mobile station.

DOWNLINK: Measures signals form the base station.

Offset Level

Sets the reference level offset value to within a range of -100dB to +100dB.

Frequency Input

Sets the method used to enter the center frequency to the instrument.

FREQUENCY: Enters a frequency.

CHANNEL: Enters a channel number.

Cont Auto Level Set

Selects the mode in which the reference level is automatically set to an optimum value according to the signal to be measured.

ON: Auto ranging is carried out on a measurement basis.

OFF: The auto ranging is not carried out.

NOTE: *The signal level must remain constant while Auto Level is being set.*

4 REMOTE CONTROL

4.1 GPIB Command Index

This GPIB command index can be used as the index for Chapter 4.

*CLS	4-30	COMMSYS IS95	4-6
*ESE	4-30	COMMSYS PDC	4-6
*ESR	4-30	COMMSYS PHS	4-6
*IDN	4-30	COMMSYS WCDMA	4-6
*RST	4-30	DB	4-29
*SRE	4-30	DC0	4-8
*STB	4-30	DC1	4-8
.....	4-29	DC2	4-8
0 to 9.....	4-29	DEL	4-9
AA	4-6	DEL REG_nn	4-9
AD	4-30	DELSTBL	4-16
ALS OFF	4-11	DL0	4-30
ALS ON	4-11	DL1	4-30
AS	4-7	DL2	4-30
AT	4-6	DL3	4-30
ATMIN	4-6	DL4	4-30
ATMIN OFF	4-6	D TSAUTOLVL	4-21
ATMIN ON	4-6	D TSAVG	4-21
AUTOFML	4-26	D TSDet NEG	4-21
AUTOLVL	4-26, 4-28	D TSDet NRM	4-21
AUTOWFL	4-11	D TSDet POS	4-21
AVGFMD	4-26	D TSDet SMP	4-21
BA	4-7	D T SFRMD CFSP	4-22
CF	4-7	D T SFRMD STSP	4-22
CH	4-10	D T SJDG OFF	4-22
CHEDDN1	4-10	D T SJDG ON	4-22
CHEDDN2	4-10	D T S MEAS	4-22
CHEDDN3	4-10	D T S MKR CLR	4-21
CHEDUP1	4-10	D T S MKR CP	4-21
CHEDUP2	4-10	D T S MKR ED	4-21
CHEDUP3	4-10	D T S REF MKR	4-22
CHSETSTD	4-11	D T S REF MOD	4-22
CHTBL1 DSBL	4-10	D T S RES ABS	4-22
CHTBL1 ENBL	4-10	D T S RES MKR	4-22
CHTBL2 DSBL	4-10	D T S RES REL	4-22
CHTBL2 ENBL	4-10	D T S RFACT	4-22
CHTBL3 DSBL	4-10	D T S SETSTD	4-22
CHTBL3 ENBL	4-10	D T S SYMRT	4-22
CLDC	4-11	D T S TMPL OFF	4-21
COMMSYS DECT	4-6	D T S TMPL ON	4-21
COMMSYS FMDEV	4-6	D T S TMPL BTM	4-22
COMMSYS GSM	4-6	D T S TMPL CLR	4-21
COMMSYS IS-136	4-6	D T S TMPL DX	4-21

4.1 GPIB Command Index

DTSTMPLED	4-21	FDSTBLED	4-25
DTSTMPLPW OFF	4-21, 4-22	FDSUNIT DBM	4-25
DTSTMPLPW ON	4-21, 4-22	FDSUNIT DBUV	4-25
DTSTMPLSX	4-21	FDSUNIT W.....	4-25
DTSTMPLSY	4-21	FINPMD CHL	4-10
DTSUNIT DBM	4-21	FINPMD FREQ.....	4-10
DTSUNIT DBUV	4-21	FMALS OFF.....	4-11
DTSUNIT W.....	4-21	FMALS ON	4-11
ENT	4-29	FMAVG.....	4-26
ERRNO	4-30	FMDEV	4-26
FA	4-7	FMDIS	4-27
FB.....	4-7	FMEPHS.....	4-26
FDPAUTOLVL	4-18	FMFA	4-26
FDPAVG	4-19	FMGTYP FFT	4-26
FDPDET NEG	4-19	FMGTYP NUM.....	4-26
FDPDET NRM	4-19	FMGTYP TMFR.....	4-26
FDPDET POS	4-19	FMHARM	4-27
FDPDET SMP	4-19	FMHPF	4-26
FDPDIV P10DB	4-19	FMLPF.....	4-26
FDPDIV P2DB	4-19	FMNPK	4-26
FDPDIV P5DB	4-19	FMPPK	4-26
FDPJDG OFF	4-19	FMRMS	4-26
FDPJDG ON	4-19	FMRNG	4-26
FDPJDGLOW.....	4-19	FMSP	4-26
FDPJDGUP.....	4-19	FMTIME.....	4-26
FDPMEAS	4-20	FUNDFRQ.....	4-27
FDPSETSTD	4-19	FUNDLVL.....	4-27
FDPUNIT DBM	4-19	GPHX	4-27
FDPUNIT DBUV	4-19	GPHY	4-28
FDPUNIT W.....	4-19	GZ.....	4-29
FDPWDO OFF	4-19	HCOPY.....	4-6
FDPWDO ON.....	4-19	HZ.....	4-29
FDPWPOS	4-19	IP.....	4-8
FDPWWID	4-19	KZ.....	4-29
FDSAUTOLVL	4-24	LC	4-30
FDSAVG	4-25	LINK DOWN	4-10
FDSCLR	4-25	LINK UP.....	4-10
FDSDET NEG	4-25	MA.....	4-29
FDSDET NRM	4-25	MF	4-8
FDSDET POS	4-25	MFL	4-8
FDSDET SMP	4-25	MK.....	4-8
FDSJDG OFF	4-25	MKBW	4-8
FDSJDG ON	4-25	MKD.....	4-8
FDSL.....	4-25	MKN.....	4-8
FDSMEAS	4-25	MKOFF	4-8
FDSPKMKY	4-25	ML	4-8
FDSPRE 16G.....	4-25	MO.....	4-8
FDSPRE 36G.....	4-25	MODTYP AMPS	4-10
FDSSETSTD	4-25	MODTYP JTACS.....	4-10
FDSSV	4-25	MODTYP NTACS	4-10
FDSTBL.....	4-24	MS	4-29
		MV	4-29

MW	4-29	RC	4-8
MZ	4-29	RC REG_nn	4-8
OBWAUTOLVL	4-20	RCLTBL	4-16
OBWAVG	4-20	RL.....	4-7
OBWDET NEG	4-20	RO	4-10
OBWDET NRM	4-20	RQS.....	4-30
OBWDET POS	4-20	S0.....	4-30
OBWDET SMP	4-20	S1.....	4-30
OBWJDG OFF	4-20	S2.....	4-30
OBWJDG ON.....	4-20	SC.....	4-29
OBWJDGLOW.....	4-20	SETFUNC CW.....	4-6
OBWJDGUP.....	4-20	SETFUNC TRAN.....	4-6
OBWMEAS.....	4-20	SI	4-13, 4-15, 4-17, 4-20, 4-22, 4-24, 4-25, 4-26
OBWPER.....	4-20	SINAD.....	4-27
OBWSETSTD	4-20	SP	4-9
OORAUTOLVL.....	4-14	SPRAUTOLVL.....	4-23
OORAVG	4-14	SPRAVG	4-23
OORDET NEG.....	4-15	SPRDET NEG.....	4-23
OORDET NRM	4-15	SPRDET NRM.....	4-23
OORDET POS.....	4-15	SPRDET POS.....	4-23
OORDET SMP	4-15	SPRDET SMP.....	4-23
OORDIV P10DB	4-14	SPRFRMD CFSP.....	4-24
OORDIV P2DB	4-14	SPRFRMD STSP	4-24
OORDIV P5DB	4-14	SPRJDG OFF.....	4-24
OORJDG OFF	4-15	SPRJDG ON.....	4-24
OORJDG ON.....	4-15	SPRMEAS.....	4-24
OORJDGUP.....	4-15	SPRMKRCLR.....	4-23
OORMEAS.....	4-15	SPRMKRCP	4-23
OORSETSTD	4-15	SPRMKRED	4-23
OORTRGDT.....	4-14	SPRPKMKY	4-24
OORTRGLVL	4-14	SPRREF MKR	4-24
OORTRGPOS.....	4-14	SPRREF MOD	4-24
OORTRGSLP FALL.....	4-14	SPRES ABS	4-24
OORTRGSLP RISE	4-14	SPRES MKR	4-24
OORTRGSRC EXT.....	4-14	SPRES REL.....	4-24
OORTRGSRC FREE.....	4-14	SPRSETSTD	4-24
OORTRGSRC IF.....	4-14	SPRTMPL OFF.....	4-23
OORTRGSRC VIDEO.....	4-14	SPRTMPL ON	4-23
OORUNIT DBM	4-15	SPRTMPLBTM	4-24
OORUNIT DBUV	4-15	SPRTMPLCLR	4-23
OORUNIT W.....	4-15	SPRTMPLCP	4-23
OORWDO OFF	4-14	SPRTMPLDX	4-23
OORWDO ON.....	4-14	SPRTMPLED.....	4-23
OORWOFPOS.....	4-14	SPRTMPLPW OFF.....	4-23
OORWOFWID.....	4-14	SPRTMPLPW ON	4-23
OORWONPOS.....	4-14	SPRTMPLSX.....	4-23
OORWONWID	4-14	SPRTMPLSY.....	4-23
OPR.....	4-30	SPRUNIT DBM.....	4-23
OPREVT	4-30		
PS	4-8		
RB	4-7		

4.1 GPIB Command Index

SPRUNIT DBUV	4-23	TDSAVG	4-17
SPRUNIT W	4-23	TDSCLR	4-16
SPULVL	4-18	TDSDET NEG	4-17
SPUR	4-17	TDSDET NRM	4-17
ST	4-7	TDSDET POS	4-17
SV	4-9	TDSDET SMP	4-17
SV REG_nn	4-9	TDSJDG OFF	4-17
SVSTBL	4-16	TDSJDG ON	4-17
SW	4-7	TDSL D	4-16
TDPAUTOLVL	4-11	TDSMEAS	4-17, 4-18
TDPAVG	4-12	TDSMULTI	4-17
TDPDET NEG	4-13	TDSPKMKY	4-17
TDPDET NRM	4-13	TDSPRE 16G	4-17
TDPDET POS	4-13	TDSPRE 36G	4-17
TDPDET SMP	4-13	TDSRES PK	4-17
TDPDIV P10DB	4-12	TDSRES RMS	4-17
TDPDIV P2DB	4-12	TDSSETSTD	4-17
TDPDIV P5DB	4-12	TDSSV	4-16
TDPJDG OFF	4-13	TDSTBL	4-16
TDPJDG ON	4-13	TDSTBLED	4-16
TDPJDGLOW	4-13	TDSTBLF ABS	4-16
TDPJDGUP	4-13	TDSTBLF REL	4-16
TDPMEAS	4-13	TDSTRGDT	4-16
TDPSETSTD	4-13	TDSTRGLVL	4-16
TDPTMPL OFF	4-12	TDSTRGPOS	4-16
TDPTMPL ON	4-12	TDSTRGSLP FALL	4-16
TDPTMPLBTM	4-13	TDSTRGSLP RISE	4-16
TDPTMPLCLR	4-12	TDSTRGSRC EXT	4-16
TDPTMPLED	4-12	TDSTRGSRC FREE	4-16
TDPTMPLPW OFF	4-13	TDSTRGSRC IF	4-16
TDPTMPLPW ON	4-13	TDSUNIT DBM	4-17
TDPTMPLSEL LOW	4-12	TDSUNIT DBUV	4-17
TDPTMPLSEL UP	4-12	TDSUNIT W	4-17
TDPTMPLSX	4-12	TGTDET NEG	4-19
TDPTMPLSY	4-12	TGTDET NRM	4-19
TDPTRGDT	4-11	TGTDET POS	4-19
TDPTRGLVL	4-11	TGTDET SMP	4-19
TDPTRGPOS	4-11	TGTPOS	4-18
TDPTRGSLP FALL	4-11	TGTSETUP OFF	4-18
TDPTRGSLP RISE	4-11	TGTSETUP ON	4-18
TDPTRGSRC EXT	4-11	TGTSRC EXT	4-18
TDPTRGSRC FREE	4-11	TGTSRC TRG	4-18
TDPTRGSRC IF	4-11	TGTSWP OFF	4-19
TDPTRGSRC VIDEO	4-11	TGTSWP ON	4-19
TDPUNIT DBM	4-13	TGTTRG EXT	4-18
TDPUNIT DBUV	4-13	TGTTRG FREE	4-18
TDPUNIT W	4-13	TGTTRG IF	4-18
TDPWDO OFF	4-12	TGTTRG VIDEO	4-18
TDPWDO ON	4-12	TGTTRGDT	4-18
TDPWPOS	4-12	TGTTRGLVL	4-18
TDPWWID	4-12	TGTTRGPOS	4-18
TDSAUTOLVL	4-16	TGTTRGSLP FALL	4-18

TGTTRGSLP RISE	4-18
TGTWID	4-18
THD	4-27
THDN	4-27
TRGDT	4-11
TRGLVL	4-11
TRGPOS	4-11
TRGSLP FALL	4-11
TRGSLP RISE	4-11
TRGSRC EXT	4-11
TRGSRC FREE	4-11
TRGSRC IF	4-11
TRGSRC VIDEO	4-11
TRSPMD EXT	4-16
TRSPMD FREE	4-16
TRSPMD IF	4-16
TRSPSLP FALL	4-16
TRSPSLP RISE	4-16
TWDO OFF	4-12
TWDO ON	4-12
TWDX	4-12
TWLX	4-12
TXAVG	4-28
TXPWR	4-28
TXTIME	4-28
US	4-29
VA	4-7
VB	4-7
XDB	4-8
XDL	4-8
XDR	4-8

4.2 GPIB Command Codes

4.2 GPIB Command Codes

The following table list the GPIB commands by function.

Table 4-1 Operating mode

Function		Listener Code	Talker Request		Remarks
			Code	Output Format	
Operating mode	Spectrum analyzer mode	SETFUNC CW	SETFUNC?	0: Spectrum analyzer 1: TRANSIENT	
	TRANSIENT mode	SETFUNC TRAN			
Communication System	WCDMA mode	COMMSYS WCDMA	COMMSYS?	1: W CDMA 2: IS-95 3: PDC 4: PHS 5: IS-136 6: GSM 7: DECT 8: AMPS/JTACS/ NTACS	*1
	IS-95 mode	COMMSYS IS95			
	PDC mode	COMMSYS PDC			
	PHS mode	COMMSYS PHS			
	IS-136 mode	COMMSYS IS136			
	GSM mode	COMMSYS GSM			
	DECT mode	COMMSYS DECT			
	AMPS/JTACS/NTACS mode	COMMSYS FMDEV			

*1: Listener code is available only when the analyzer is set to the CW mode. The codes within the talker request are available for both the CW and TRANSIENT modes.

Table 4-2 ATT key (Attenuator)

Function		Listener Code	Talker Request		Remarks
			Code	Output Format	
Attenuator	AT	AT *	AT?	Level	
	ATT AUTO	AA	AA?	0: Manual 1: AUTO	
	Min. ATT	ATMIN *	ATMIN?	Level	
	Min. ATT ON OFF	ATMIN ON [*] ATMIN OFF	ATMINON?	0: OFF 1: ON	

Table 4-3 COPY key (Hand copy)

Function		Listener Code	Talker Request		Remarks
			Code	Output Format	
Printer output					
File output		HCOPY	-	-	

Table 4-4 COUPLE key (Couple function)

Function	Listener Code	Talker Request		Remarks
		Code	Output Format	
Couple function	RBW	RB *	RB?	Frequency
	RBW AUTO	BA	BA?	0: Manual 1: AUTO
	VBW	VB *	VB?	Frequency
	VBW AUTO	VA	VA?	0: Manual 1: AUTO
	Sweep Time	SW * ST *	SW? ST?	Time
	Sweep Time Auto	AS	AS?	0: Manual 1: AUTO

Table 4-5 FREQ key (Frequency)

Function	Listener Code	Talker Request		Remarks
		Code	Output Format	
Frequency	Center frequency	CF *	CF?	Frequency
	Start frequency	FA *	FA?	Frequency
	Stop frequency	FB *	FB?	Frequency

Table 4-6 LEVEL key (Reference Level)

Function	Listener Code	Talker Request		Remarks
		Code	Output Format	
Reference level	RL *	RL?	Level	

4.2 GPIB Command Codes

Table 4-7 MKR key (Marker)

Function		Listener Code	Talker Request		Remarks
			Code	Output Format	
Marker	ΔMarker ON	MKD [*]	-	Frequency (Time)	
	OFF	MKOFF MO	- -	- -	
	Reading marker frequency (time)	-	MF?	Frequency (Time)	
	Reading marker level	-	ML?	Level	
	Reading marker frequency (time) and marker level	-	MFL?	Frequency (Time), Level	
	Normal marker	MK [*] MKN [*]	- -	Frequency (Time)	
	Peak search	PS			
	X-dB Down				
X-dB Down width	MKBW *	MKBW?	Level		
X-dB Down	XDB	-			
X-dB Down Left	XDL	-			
Right	XDR	-			
Display mode REL.	DC0	DC?	0: Relative mode		
ABS.L.	DC1		1: Absolute mode (Left side)		
ABS.R.	DC2		2: Absolute mode (Right side)		

Table 4-8 PRESET Key (Initialization)

Function		Listener Code	Talker Request		Remarks
			Code	Output Format	
Preset	Instrument preset	IP	-	-	

Table 4-9 RCL Key (Recall)

Function		Listener Code	Talker Request		Remarks
			Code	Output Format	
Recall	RC REG_nn		-	nn: 01 to 10	
	RC file name		-	File name: Max.8 character	

Table 4-10 SAVE Key (Save)

Function		Listener Code	Talker Request		Remarks
			Code	Output Format	
Save	Save	SV REG_nn SV file name	- -	nn: 01 to 10 File name: Max.8 character	
	Deletion	DEL REG_nn DEL file name	- -	nn: 01 to 10 File name: Max.8 character	

Table 4-11 SPAN Key (Frequency span)

Function		Listener Code	Talker Request		Remarks
			Code	Output Format	
Frequency Span		SP *	SP?	Frequency	

4.2 GPIB Command Codes

Table 4-12 TRANSIENT Key (1 of 19)

Function	Listener Code	Talker Request		Remarks
		Code	Output Format	
STD Setup	Communication System			
	AMPS	MODTYP AMPS	MODTYP?	0: AMPS
	JTACS	MODTYP JTACS		1: JTACS
	NTACS	MODTYP NTACS		2: NTACS
	LINK			
	UPLINK	LINK UP	LINK?	0: UPLINK
	DOWNLINK	LINK DOWN		1: DOWNLINK
	Offset Level	RO *	RO?	Level
	Freq.Setting mode			
	Freq.Input mode	FINPMD FREQ	FINPMD?	0:Frequency Input
	Channel Input mode	FINPMD CHL		1:Channel Input
	Channel Setting	CH *	CH?	Integer (Channel No.)
	Channel Edit			
	Input #1 (UPLINK)	CHEDUP1 *,*,*,*	CHEDUP1?	ch1,ch2,f1,f2,chof
	Input #2 (UPLINK)	CHEDUP2 *,*,*,*	CHEDUP2?	ch1,ch2,f1,f2,chof
	Input #3 (UPLINK)	CHEDUP3 *,*,*,*	CHEDUP3?	ch1,ch2,f1,f2,chof
	Input #1 (DOWNLINK)	CHEDDN1 *,*,*,*	CHEDDN1?	ch1,ch2,f1,f2,chof
	Input #2 (DOWNLINK)	CHEDDN2 *,*,*,*	CHEDDN2?	ch1,ch2,f1,f2,chof
	Input #3 (DOWNLINK)	CHEDDN3 *,*,*,*	CHEDDN3?	ch1,ch2,f1,f2,chof
				ch1: Start channel no. ch2: Stop channel no. f1: Base frequency(Hz) f2: Channel space(Hz) chof: Channel Offset (Units of frequency are necessary for f1 and f2.)
	Selection of ENABLE or DISABLE for channel table			
#1 ENABLE	CHTBL1 ENBL	CHTBL1?	0: Disable	
DISABLE	CHTBL1 DSBL		1: Enable	
#2 ENABLE	CHTBL2 ENBL	CHTBL2?	0: Disable	
DISABLE	CHTBL2 DSBL		1: Enable	
#3 ENABLE	CHTBL3 ENBL	CHTBL3?	0: Disable	
DISABLE	CHTBL3 DSBL		1: Enable	

Table 4-12 TRANSIENT Key (2 of 19)

Function	Listener Code	Talker Request		Remarks
		Code	Output Format	
STD Setup	Channel			
	Copy from STD	CHSETSTD		
	Auto Level Setting			
	Auto Level OFF	ALS OFF FMALS OFF	ALS? FMALS?	0: OFF 1: ON
Auto Level ON	ALS ON FMALS ON			
DC CAL	CLDC			
T-Domain Power	Auto Level Set	AUTOWFL TDPAUTOLVL		
	Trigger Setup			
	Trigger Source			
	FREERUN	TRGSRC FREE TDPTRGSRC FREE	TRGSRC? TDPTRGSRC?	0: FREERUN 1: VIDEO
	VIDEO	TRGSRC VIDEO TDPTRGSRC VIDEO		2: IF 3: EXT
	IF	TRGSRC IF TDPTRGSRC IF		
	EXT	TRGSRC EXT TDPTRGSRC EXT		
	Trigger Slope			
	+	TRGSLP RISE TDPTRGSLP RISE	TRGSLP? TDPTRGSLP?	0: - 1: +
	-	TRGSLP FALL TDPTRGSLP FALL		
Trigger Level	TRGLVL * TDPTRGLVL *	TRGLVL? TDPTRGLVL?	Integer (0 to 100)	
Trigger Position	TRGPOS * TDPTRGPOS *	TRGPOS? TDPTRGPOS?	Integer (0 to 100)	
Delay Time	TRGDT * TDPTRGDT *	TRGDT? TDPTRGDT?	Time	

4.2 GPIB Command Codes

Table 4-12 TRANSIENT Key (3 of 19)

Function	Listener Code	Talker Request		Remarks	
		Code	Output Format		
T-Domain Power	Window Setup				
	Window				
	ON	TDPWDO ON TWDO ON	TDPWDO? TWDO?	0: OFF 1: ON	
	OFF	TDPWDO OFF TWDO OFF			
	Window Position	TDPWPOS * TWLX *	TDPWPOS? TWLX?	Time	
	Window Width	TDPWWID * TWDX *	TDPWWID? TWDX?	Time	
	Y Scale				
	10dB/div	TDPDIV P10DB	TDPDIV?	0: 10dB/div	
	5dB/div	TDPDIV P5DB		1: 5dB/div	
	2dB/div	TDPDIV P2DB		2: 2dB/div	
	Average Times	TDPAVG *	TDPAVG?	Integer (1: OFF, 2 to 999)	
	Template				
Template					
ON	TDPTMPL ON	TDPTMPL?	0: OFF		
OFF	TDPTMPL OFF		1: ON		
Template Shift					
Shift X	TDPTMPLSX *	TDPTMPLSX?	Time		
Shift Y	TDPTMPLSY *	TDPTMPLSY?	Level		
Template Edit					
Template UP/LOW Select	TDPTMPLSEL UP TDPTMPLSEL LOW	TDPTMPLSEL?	0: UP 1: LOW		
Data Input	TDPTMPLED *,*		t1, l1 t1: Time l1: Level		
Init Table	TDPTMPLCLR		(dBm/W/dBµV)		

Table 4-12 TRANSIENT Key (4 of 19)

Function	Listener Code	Talker Request		Remarks
		Code	Output Format	
T-Domain Power	Parameter Setup			
	Detector			
	Normal	TDPDET NRM	TDPDET?	0: Normal
	Posi	TDPDET POS		1: Posi
	Nega	TDPDET NEG		2: Nega
	Sample	TDPDET SMP		3: Sample
	Display Unit			
	dBm	TDPUNIT DBM	TDPUNIT?	0: dBm
	W	TDPUNIT W		1: W
	dB μ V	TDPUNIT DBUV		2: dB μ V
	Template Couple to Power			
	ON	TDPTMPLPW ON	TDPTMPLPW?	0: OFF
	OFF	TDPTMPLPW OFF		1: ON
	Template Limit	TDPTMPLBTM *	TDPTMPLBTM?	Level (dBm/W/dB μ V)
Judgement				
ON	TDPJDG ON	TDPJDG?	0: OFF	
OFF	TDPJDG OFF		1: ON	
Upper Limit	TDPJDGUP *	TDPJDGUP?	Level	
Lower Limit	TDPJDGLOW *	TDPJDGLOW?	Level	
Set to STD	TDPSETSTD			
Starts measurement				
T-Domain Power	TDPMEAS			
Starts measurement in the same mode	SI			
Measurement results				
T-Domain Power		TDPMEAS?	l1, j1 l1: Level (dBm/W/dB μ V) j1: Integer (0: FAIL, 1: PASS, -1: Judgement OFF)	

4.2 GPIB Command Codes

Table 4-12 TRANSIENT Key (5 of 19)

Function	Listener Code	Talker Request		Remarks
		Code	Output Format	
ON/OFF Ratio	Auto Level Set	OORAUTOLVL		
	Trigger Setup			
	Trigger Source			
	FREERUN	OORTRGSRC FREE	OORTRGSRC?	0: FREERUN
	VIDEO	OORTRGSRC VIDEO		1: VIDEO
	IF	OORTRGSRC IF		2: IF
	EXT	OORTRGSRC EXT		3: EXT
	Trigger Slope			
	+	OORTRGSLP RISE	OORTRGSLP?	0: -
	-	OORTRGSLP FALL		1: +
	Trigger Level	OORTRGLVL*	OORTRGLVL?	Integer (0 to 100)
	Trigger Position	OORTRGPOS *	OORTRGPOS?	Integer (0 to 100)
	Delay Time	OORTRGDT *	OORTRGDT?	Time
	Window Setup			
	Window			
	ON	OORWDO ON	OORWDO?	0: OFF
	OFF	OORWDO OFF		1: ON
	ON Position	OORWONPOS *	OORWON-POS?	Time
	ON Width	OORWONWID *	OORWONWID?	Time
OFF Position	OORWOFPOS *	OORWOFPOS?	Time	
OFF Width	OORWOFWID *	OORWOF-WID?	Time	
Y Scale				
10dB/div	OORDIV P10DB	OORDIV?	0: 10dB/div	
5dB/div	OORDIV P5DB		1: 5dB/div	
2dB/div	OORDIV P2DB		2: 2dB/div	
Average Times	OORAVG *	OORAVG?	Integer (1: OFF, 2 to 999)	

Table 4-12 TRANSIENT Key (6 of 19)

Function	Listener Code	Talker Request		Remarks
		Code	Output Format	
ON/OFF Ratio	Parameter Setup			
	Detector			
	Normal	OORDET NRM	OORDET?	0: Normal
	Posi	OORDET POS		1: Posi
	Nega	OORDET NEG		2: Nega
	Sample	OORDET SMP		3: Sample
	Display Unit			
	dBm	OORUNIT DBM	OORUNIT?	0: dBm
	W	OORUNIT W		1: W
	dB μ V	OORUNIT DBUV		2: dB μ V
Judgement				
ON	OORJDG ON	OORJDG?	0: OFF	
OFF	OORJDG OFF		1: ON	
Upper Limit	OORJDGUP *	OORJDGUP?	Level	
Set to STD	OORSETSTD			
Starts measurement				
ON/OFF Ratio	OORMEAS			
Starts measurement in the same mode	SI			
Measurement results				
ON/OFF Ratio		OORMEAS?	I1, I2, d1, j1 I1: ON Level (dBm/W/dB μ V) I2: OFF Level (dBm/W/dB μ V) d1: ON/OFF Ratio(dB) j1: Integer (0: FAIL, 1: PASS, -1: Judgement OFF)	

4.2 GPIB Command Codes

Table 4-12 TRANSIENT Key (7 of 19)

Function	Listener Code	Talker Request		Remarks
		Code	Output Format	
T-Domain Spurious	Auto Level Set	TDSAUTOLVL		
	Trigger Setup			
	Trigger Source			
	FREERUN	TDSTRGSRC FREE TRSPMD FREE	TDSTRGSRC?	0: FREERUN
	IF	TDSTRGSRC IF TRSPMD IF	TRSPMD?	2: IF 3: EXT
	EXT	TDSTRGSRC EXT TRSPMD EXT		
	Trigger Slope			
	+	TDSTRGSLP RISE TRSPSLP RISE	TDSTRGSLP?	0: - 1: +
	-	TDSTRGSLP FALL TRSPSLP FALL	TRSPSLP?	
	Trigger Level	TDSTRGLVL *	TDSTRGLVL?	Integer (0 to 100)
	Trigger Position	TDSTRGPOS *	TDSTRGPOS?	Integer (0 to 100)
	Delay Time	TDSTRGDT *	TDSTRGDT?	Time
	Table			
	Table No. 1/2/3	TDSTBL *	TDSTBL?	Integer (1 to 3)
	Table Edit	TDSTBLED *,*		f1, l1 f1: Frequency l1: Limit Level
Load Table	TDSL RCLTBL *		Integer (1 to 3)	
Save Table	TDSSV SVSTBL *		Integer (1 to 3)	
Init Table	TDSCLR DELSTBL			
Table Freq. Input				
ABS	TDSTBLF ABS	TDSTBLF?	0: ABS	
REL	TDSTBLF REL		1: REL	

Table 4-12 TRANSIENT Key (8 of 19)

Function	Listener Code	Talker Request		Remarks	
		Code	Output Format		
T-Domain Spurious	Average Times	TDSAVG *	TDSAVG?	Integer (1: OFF, 2 to 999)	
	Parameter Setup				
	Detector				
	Normal	TDSDET NRM	TDSDET?	0: Normal	
	Posi	TDSDET POS		1: Posi	
	Nega	TDSDET NEG		2: Nega	
	Sample	TDSDET SMP		3: Sample	
	Display Unit				
	dBm	TDSUNIT DBM	TDSUNIT?	0: dBm	
	W	TDSUNIT W		1: W	
	dB μ V	TDSUNIT DBUV		2: dB μ V	
	Judgement				
	ON	TDSJDG ON	TDSJDG?	0: OFF	
	OFF	TDSJDG OFF		1: ON	
	Result				
	Peak	TDSRES PK	TDSRES?	0: Peak	
	RMS	TDSRES RMS		1: RMS	
	Multiplier	TDSMULTI *	TDSMULTI?	Real Number	
	Peak MKR Y-Delta	TDSPKMKY *	TDSPKMKY?	Real Number	
	Preselector 1.6G	TDSPRE 16G	TDSPRE?	0: 1.6G	
	3.6G	TDSPRE 36G		1: 3.6G	
	Set to Default	TDSSETSTD			
	Starts measurement				
	Spurious	TDSMEAS SPUR			
	Starts measurement in the same mode	SI			

4.2 GPIB Command Codes

Table 4-12 TRANSIENT Key (9 of 19)

Function		Listener Code	Talker Request		Remarks
			Code	Output Format	
T-Domain Spurious	Measurement results				
	Spurious		TDSMEAS? SPULVL?	n<CR+LF>+f1,l1,j1<CR+LF> >..... +fn,ln,jn<CR+LF> n: Amount (Integer) fn: Frequency ln: Level (dBm/W/dBµV) jn: Integer (0: FAIL, 1: PASS, -1: Judgement OFF) n<CR+LF>+f1,l1<CR+LF> +fn,ln<CR+LF> n: Amount (Integer) fn: Frequency ln: Level (dBm/W/dBµV)	
F-Domain Power	Auto Level Set	FDPAUTOLVL			
	Gate Setup				
	ON	TGTSETUP ON	TGTSETUP?	0: OFF	
	OFF	TGTSETUP OFF		1: ON	
	Trigger Source				
	FREE RUN	TGTTRG FREE	TGTTRG?	0: FREERUN	
	VIDEO	TGTTRG VIDEO		1: VIDEO	
	IF	TGTTRG IF		2: IF	
	EXT	TGTTRG EXT		3: EXT	
	Trigger Slope				
	-	TGTTRGSLP FALL	TGTTRGSLP?	0: -	
	+	TGTTRGSLP RISE		1: +	
	Trigger Level	TGTTRGLVL *	TGTTRGLVL?	Integer (0 to 100)	
Trigger Position	TGTTRGPOS *	TGTTRGPOS?	Integer (0 to 100)		
Delay Time	TGTTRGDT *	TGTTRGDT?	Time		
Gate Source					
Trigger	TGTSRC TRG	TGTSRC?	0: Trigger		
Ext Gate	TGTSRC EXT		1: EXT		
Gate Position	TGTPOS *	TGTPOS?	Time		
Gate Width	TGTWID *	TGTWID?	Time		

Table 4-12 TRANSIENT Key (10 of 19)

Function	Listener Code	Talker Request		Remarks
		Code	Output Format	
F-Domain Power	Detector			
	Normal	TGTDET NRM	TGTDET?	0: Normal
	Posi	TGTDET POS		1: Posi
	Nega	TGTDET NEG		2: Nega
	Sample	TGTDET SMP		3: Sample
	Gated Sweep ON/OFF			
	ON	TGTSWP ON	TGTSWP?	0: OFF
	OFF	TGTSWP OFF		1: ON
	Window Setup			
	Window			
	ON	FDPWDO ON	FDPWDO?	0: OFF
	OFF	FDPWDO OFF		1: ON
	Window Position	FDPWPOS *	FDPWPOS?	Frequency
	Window Width	FDPWWID *	FDPWWID?	Frequency
	Y Scale			
	10dB/div	FDPDIV P10DB	FDPDIV?	0: 10dB/div
	5dB/div	FDPDIV P5DB		1: 5dB/div
	2dB/div	FDPDIV P2DB		2: 2dB/div
	Average Times	FDPAVG *	FDPAVG?	Integer (1: OFF, 2 to 999)
	Parameter Setup			
	Detector			
	Normal	FDPDET NRM	FDPDET?	0: Normal
	Posi	FDPDET POS		1: Posi
	Nega	FDPDET NEG		2: Nega
	Sample	FDPDET SMP		3: Sample
	Display Unit			
	dBm	FDPUNIT DBM	FDPUNIT?	0: dBm
W	FDPUNIT W		1: W	
dB μ V	FDPUNIT DBUV		2: dB μ V	
Judgement				
ON	FDPJDG ON	FDPJDG?	0: OFF	
OFF	FDPJDG OFF		1: ON	
Upper Limit	FDPJDGUP *	FDPJDGUP?	Level (dBm/W/dB μ V)	
Lower Limit	FDPJDGLOW *	FDPJDG- LOW?	Level (dBm/W/dB μ V)	
Set to STD	FDPSETSTD			

4.2 GPIB Command Codes

Table 4-12 TRANSIENT Key (11 of 19)

Function	Listener Code	Talker Request		Remarks
		Code	Output Format	
F-Domain Power	Starts measurement	FDPMEAS		
	F-Domain Power Starts measurement in the same mode	SI		
	Measurement results			
	F-Domain Power	FDPMEAS?	l1, j1 l1: Level (dBm/W/dBµV) j1: Integer (0: FAIL, 1: PASS, -1: Judgement OFF)	
OBW	Auto Level Set	OBWAUTOLVL		
	OBW%	OBWPER *	OBWPER?	Real Number (0.5 to 99.5)
	Average Times	OBWAVG *	OBWAVG?	Integer (1: OFF, 2 to 999)
	Parameter Setup			
	Detector			
	Normal	OBWDET NRM	OBWDET?	0: Normal
	Posi	OBWDET POS		1: Posi
	Nega	OBWDET NEG		2: Nega
	Sample	OBWDET SMP		3: Sample
	Judgement			
ON	OBWJDG ON	OBWJDG?	0: OFF	
OFF	OBWJDG OFF		1: ON	
Upper Limit	OBWJDGUP *	OBWJDGUP?	Frequency	
Lower Limit	OBWJDGLOW *	OBWJDGLOW?	Frequency	
Set to STD	OBWSETSTD			
Starts measurement				
OBW	OBWMEAS			
Starts measurement in the same mode	SI			
Measurement results				
OBW		OBWMEAS?	f1, f2, f3, j1 f1: OBW Frequency f2: Lower side Frequency f3: Higher side Frequency j1: Integer (0: FAIL, 1: PASS, -1: Judgement OFF)	

Table 4-12 TRANSIENT Key (12 of 19)

Function	Listener Code	Talker Request		Remarks
		Code	Output Format	
ACP Due to Transient	Auto Level Set	DTSAUTOLVL		
	Template			
	Template			
	ON	DTSTMPL ON	DTSTMPL?	0: OFF
	OFF	DTSTMPL OFF		1: ON
	Template Shift			
	Shift X	DTSTMPLSX *	DTSTMPLSX?	Frequency
	Shift Y	DTSTMPLSY *	DTSTMPLSY?	Level
	Margin delta X	DTSTMPLDX *	DTSTMPLDX?	Frequency (0: OFF)
	Data Input	DTSTMPLD *,*		f1, l1 f1: Frequency l1: Level (dBm/W/dBμV)
	Init Table	DTSTMPLCLR		
	Marker Edit			
	Copy from STD	DTSMKRCP		
	Data Input	DTSMKRED *,*,*,*		d1, f1, f2, l1 d1: (0: Normal, 1: Integral, 2: √Nyquist) f1: Offset frequency f2: Bandwidth l1: Limit Level
Init Table	DTSMKRCLR			
Average Times	DTSAVG *	DTSAVG?	Integer (1: OFF, 2 to 999)	
Parameter Setup				
Detector				
Normal	DTSEDET NRM	DTSEDET?	0: Normal	
Posi	DTSEDET POS		1: Posi	
Nega	DTSEDET NEG		2: Nega	
Sample	DTSEDET SMP		3: Sample	
Display Unit				
dBm	DTSUNIT DBM	DTSUNIT?	0: dBm	
W	DTSUNIT W		1: W	
dBμV	DTSUNIT DBUV		2: dBμV	
Template Couple to Power				
ON	DTSTMPLPW ON	DTSTMPLPW?	0: OFF	
OFF	DTSTMPLPW OFF		1: ON	

4.2 GPIB Command Codes

Table 4-12 TRANSIENT Key (13 of 19)

Function	Listener Code	Talker Request		Remarks	
		Code	Output Format		
ACP Due to Transient	Template Couple to Power ON OFF	DTSTMPLPW ON DTSTMPLPW OFF	DTSTMPLPW?	0: OFF 1: ON	
	Template Limit	DTSTMPLBTM *	DTSTMPLBTM?	Level (dBm/W/dBµV)	
	Judgement ON OFF	DTSJDG ON DTSJDG OFF	DTSJDG?	0: OFF 1: ON	
	Freq. Setting CFSP STSP	DTSFRMD CFSP DTSFRMD STSP	DTSFRMD?	0: Center/Span Mode 1: Start/Stop Mode	
	Result ABS REL MKR	DTSRES ABS DTSRES REL DTSRES MKR	DTSRES?	0: Absolute 1: Relative 2: Marker	
	Ref Power MKR MOD	DTSREF MKR DTSREF MOD	DTSREF?	0: Reference Marker 1: Modulation	
	Symbol Rate 1/T	DTSSYMRT *	DTSSYMRT?	Frequency	
	Rolloff Factor	DTSRFACT *	DTSRFACT?	Real Number	
	Set to STD	DTSSETSTD			
	Starts measurement Due to Transient	DTSMEAS			
	Starts measurement in the same mode	SI			
	Measurement results ACP Due to Transient		DTSMEAS?	n<CR+LF>+d1,j1<CR+LF>+..... +dn,jn<CR+LF> n: Amount (Integer) dn: Power jn: Integer (0: FAIL, 1: PASS, -1: Judgement OFF)	

Table 4-12 TRANSIENT Key (14 of 19)

Function	Listener Code	Talker Request		Remarks	
		Code	Output Format		
Inband Spurious	Auto Level Set	SPRAUTOLVL			
	Template				
	Template				
	ON	SPRTMPL ON	SPRTMPL?	0: OFF	
	OFF	SPRTMPL OFF		1: ON	
	Template Shift				
	Shift X	SPRTMPLSX *	SPRTMPLSX?	Frequency	
	Shift Y	SPRTMPLSY *	SPRTMPLSY?	Level	
	Margin delta X	SPRTMPLDX *	SPRTMPLDX?	Frequency (0: OFF)	
	Copy from STD	SPRTMPLCP			
	Data Input	SPRTMPLED *,*		f1, l1 f1: Frequency l1: Level (dBm/W/dBμV)	
	Init Table	SPRTMPLCLR			
	Marker Edit				
	Copy from STD	SPRMKRCP			
	Data Input	SPRMKRED *,*,*,*		d1, f1, f2, l1 d1: (0: Peak, 1: Integral) f1: Start Frequency f2: Stop Frequency l1: Limit Level	Set the refer- ence band- width to f2, after initializ- ing the table.
	Init Table	SPRMKRCLR			
	Average Times	SPRAVG *	SPRAVG?	Integer (1: OFF, 2 to 999)	
	Parameter Setup				
	Detector				
	Normal	SPRDET NRM	SPRDET?	0: Normal	
Posi	SPRDET POS		1: Posi		
Nega	SPRDET NEG		2: Nega		
Sample	SPRDET SMP		3: Sample		
Display Unit					
dBm	SPRUNIT DBM	SPRUNIT?	0: dBm		
W	SPRUNIT W		1: W		
dBμV	SPRUNIT DBUV		2: dBμV		
Template Couple to Power					
ON	SPRTMPLPW ON	SPRTMPLPW?	0: OFF		
OFF	SPRTMPLPW OFF		1: ON		

4.2 GPIB Command Codes

Table 4-12 TRANSIENT Key (15 of 19)

Function	Listener Code	Talker Request		Remarks
		Code	Output Format	
Inband Spurious	Template Limit	SPRTMPLBTM *	SPRTMPLBTM?	Level (dBm/W/dBµV)
	Judgement			
	ON	SPRJDG ON	SPRJDG?	0: OFF
	OFF	SPRJDG OFF		1: ON
	Freq. Setting			
	CFSP	SPRFRMD CFSP	SPRFRMD?	0: Center/Span Mode
	STSP	SPRFRMD STSP		1: Start/Stop Mode
	Result			
	ABS	SPRRES ABS	SPRRES?	0: Absolute
	REL	SPRRES REL		1: Relative
MKR	SPRRES MKR		2: Marker	
Ref Power				
MKR	SPRREF MKR	SPRREF?	0: Reference Marker	
MOD	SPRREF MOD		1: Modulation	
Peak MKR Y-Delta	SPRPKMKY *	SPRPKMKY?	Real Number	
Set to STD	SPRSETSTD			
Starts measurement				
Inband Spurious	SPRMEAS			
Starts measurement in the same mode	SI			
Measurement results				
Inband Spurious		SPRMEAS?	n<CR+L.F>+f1,j1 <CR+L.F> >..... +fn,jn jn<CR+L.F> n: Amount (Integer) fn: Frequency ln: Level (dBm/W/dBµV) jn: Integer (0: FAIL, 1: PASS, -1: Judgement OFF)	
Outband Spurious	Auto Level Set	FDSAUTOLVL		
	Table			
	Table No.1/2/3	FDSTBL *	FDSTBL?	Integer (1 to 3)

Table 4-12 TRANSIENT Key (16 of 19)

Function	Listener Code	Talker Request		Remarks
		Code	Output Format	
Outband Spurious	Table Edit	FDSTBLED *,*,*,*,*,*		f1, f2, f3, f4, d1, l1 f1: Start Frequency f2: Stop Frequency f3: RBW f4: VBW d1: Sweep Time l1: Limit Level
	Load Table	FDSL D		
	Save Table	FDSSV		
	Init Table	FDSCLR		
Average Times	FDSAVG *	FDSAVG?	Integer (1:OFF, 2 to 999)	
Parameter Setup				
Detector				
Normal	FDSDET NRM	FDSDET?	0: Normal	
Posi	FDSDET POS		1: Posi	
Nega	FDSDET NEG		2: Nega	
Sample	FDSDET SMP		3: Sample	
Display Unit				
dBm	FDSUNIT DBM	FDSUNIT?	0: dBm	
W	FDSUNIT W		1: W	
dBμV	FDSUNIT DBUV		2: dBμV	
Judgement				
ON	FDSJDG ON	FDSJDG?	0: OFF	
OFF	FDSJDG OFF		1: ON	
Peak MKR Y-Delta	FDSPKMKY *	FDSPKMKY?	Real Number	
Preselector 1.6G	FDSPRE 16G	FDSPRE?	0: 1.6G	
3.6G	FDSPRE 36G		1: 3.6G	
Set to Default	FDSSETSTD			
Starts measurement				
Outband Spurious	FDSMEAS			
Starts measurement in the same mode	SI			
Measurement results				
Outband Spurious		FDSMEAS?	n<CR+LJ>+f1,l1,j1<CR+LJ> >..... +fn,ln,jn<CR+LJ> n: Amount (Integer) fn: Frequency ln: Level (dBm/W/dBmV) jn: Integer (0: FAIL, 1: PASS, -1: Judgement OFF)	

4.2 GPIB Command Codes

Table 4-12 TRANSIENT Key (17 of 19)

Function		Listener Code	Talker Request		Remarks
			Code	Output Format	
FM Devi- ation	Auto Level Set	AUTOLVL AUTOFML			
	Parameter Setup	FMEPHS *			
	De-Emphasis Filter	FMEPHS *	FMEPHS?	Time (sec)	
	Data Length	FMTIME *	FMTIME?	Time (sec)	
	Audio HPF	FMHPF *	FMHPF?	Frequency (Hz)	
	Audio LPF	FMLPF *	FMLPF?	Frequency (Hz)	
	Meas F-Range	FMRNG *	FMRNG?	Frequency (Hz)	
	Graph Time-Freq				
	START	FMFA *	FMFA?	Time (sec)	
	SPAN	FMSF *	FMSF?	Time (sec)	
Average Times	AVGFMD *	AVGFMD?	Integer (1:OFF, 2 to 32)		
Result display selection	FMGTYP TMFR FMGTYP FFT FMGTYP NUM	FMGTYP?	0:Graphic Time-Freq 1:Graphic FFT of Dmd 2:Numeric Current		
Starts measurement FM Deviation	FMDEV				
Starts measurement in the same mode	SI				
Measurement results (Deviation)					
+Peak		FMPPK?	Frequency (Hz)		
-Peak		FMNPK?	Frequency (Hz)		
(P-P)/2		FMAVG?	Frequency (Hz)		
RMS		FMRMS?	Frequency (Hz)		
CarFqEr		FMCFERR?	Frequency (Hz)		
Deviation ALL		FMDEV?	d1,d2,d3,d4,d5 d1:+Peak(Hz) d2:-Peak(Hz) d3:(P-P)/2(Hz) d4:RMS(Hz) d5:CarFqEr(Hz)		

Table 4-12 TRANSIENT Key (18 of 19)

Function	Listener Code	Talker Request		Remarks
		Code	Output Format	
FM Deviation	(Distortion)			
	SINAD		SINAD?	Level (dB)
	THD		THD?	Real Number (%)
	THD+N		THDN?	Real Number (%)
	(FM Demodulated Signal)			
	Fund Freq		FUNDFRQ?	Frequency (Hz)
	Fund Level		FUNDLVL?	Level (dBkHz)
	Dist & Demod ALL		FMDIS?	d1,d2,d3,d4,d5 d1:SINAD(dB) d2:THD(%) d3:THD+N(%) d4:Fund Freq(Hz) d5:Fund Level(dBkHz)
	(Harmonics)			(Harmonics)
	Harmonics ALL		FMHARM?	d1,d2,d3,d4,d5 d1:fn(dB) d2:2nd(dB) d3:3rd(dB) d4:4th(dB) d5:5th(dB)
Graphics Data output *For Time-Freq/FFT of Dmd X data		GPHX?	n<CR+LF>+d1<CR+LF>+.....+dn<CR+LF> n: Number of output data (Integer) dn: Time (Real Number sec) Time-Freq dn: Frequency (Real Number Hz) FFT of Dmd	

4.2 GPIB Command Codes

Table 4-12 TRANSIENT Key (19 of 19)

Function		Listener Code	Talker Request		Remarks
			Code	Output Format	
FM Deviation	Y data		GPHY?	n<CR+LF>+d1<CR+LF>+.....+dn<CR+LF> n: Number of output data (Integer) dn: Frequency (Real Number Hz) Time-Freq dn: Level (Real Number dB) FFT of Dmd	
Tx Power	Auto Level Set	AUTOLVL			
	Parameter Setup				
	Data Length	TXTIME *	TXTIME?	Time (sec)	
	Average Times	TXAVG *	TXAVG?	Integer (1:OFF, 2 to 32)	
	Starts measurement				
	Tx Power				
	Starts measurement in the same mode				
	Measurement results				
	Tx Power		TXPWR?	d1,d2 d1: Tx Power(dBm) d2: Tx Power(W)	

Table 4-13 Numeric keys/Step keys/Data knob/Unit keys (Entering data)

	Function	Listener Code	Talker Request		Remarks
			Code	Output Format	
Entering data	0 to 9	0 to 9	-	-	
	. (Decimal point)	.	-	-	
	GHz	GZ	-	-	
	MHz	MZ	-	-	
	kHz	KZ	-	-	
	Hz	HZ	-	-	
	mV	MV	-	-	
	mW	MW	-	-	
	dB	DB	-	-	
	mA	MA	-	-	
	sec	SC	-	-	
	ms	MS	-	-	
	μs	US	-	-	
	ENTER	ENT	-	-	

4.2 GPIB Command Codes

Table 4-14 Miscellaneous

Function	Listener Code	Talker Request		
		Code	Output Format	
Miscellaneous	Outputting error number	-	ERRNO?	Integer
	Local	LC	-	-
	Reading GPIB address	-	AD?	Integer (0 to 30)
	Specification of the delimiter			
	CR LF <EOI>	DL0	-	-
	LF	DL1	-	-
	<EOI>	DL2	-	-
	CR LF	DL3	-	-
	LF <EOI>	DL4	-	-
	Service request interruption			
	ON	S0	-	-
	OFF	S1	-	-
	Status clear	S2	-	-
	Service request mask	RQS *	RQS?	Decimal number corresponding to the SRQ bit
	Outputting ID of the instrument	-	*IDN?	Manufacturer name (character string), instrument type (character string), 0 and revision (character string)
	Initializing the instrument	*RST	-	-
	Clearing the queues related to the status byte	*CLS	-	-
	Accessing the standard event enable register	*ESE *	*ESE?	Decimal number corresponding to the register bits
	Reading or clearing the standard event enable register	-	*ESR?	Decimal number corresponding to the register bits
	Accessing the service request enable register	*SRE *	*SRE?	Decimal number corresponding to the register bits
	Reading the status byte and MSS bit	-	*STB?	Decimal number corresponding to the status byte
	Accessing the operation status enable register	OPR *	OPR?	Decimal number corresponding to the register bits
	Reading or clearing the operation status register	-	OPREVT?	Decimal number corresponding to the register bits

5 TECHNICAL INFORMATION

5.1 About the Measurement Result

Results are calculated from the following formula.

+Peak: Maximum frequency of the FM demodulated signal.

-Peak: Minimum frequency of the FM demodulated signal.

(P-P)/2: Mean value of absolute values of +Peak and -Peak.

RMS: Root Mean Square of the FM demodulated signal.

CarFqEr: Carrier frequency error.

$$\text{CarFqEr} = \frac{1}{N} \sum_{i=0}^{N-1} |f_{m[i]}|$$

$f_{m[i]}$: FM demodulated signal

SINAD: Signal Noise And Distortion

$$\text{SINAD}[\text{dB}] = 20 \log \left\{ \frac{(S+N+D)}{(N+D)} \right\}$$

THD: Total Harmonic Distortion (Distortion Ratio)

$$\text{THD} (\%) = D/S \times 100$$

THD+N: Total Harmonic Distortion and Noise

$$\text{THD+N} (\%) = (D+N)/S \times 100$$

S=RMS of the fundamental wave element

D=RMS of the harmonic element

N=RMS of the noise element

Harmonics: Displays up to the fifth harmonic level of the FM demodulated signal. The level of the fundamental wave is normalized to 0 dB.

5.2 About De-Emphasis Filter Time Constant

5.2 About De-Emphasis Filter Time Constant

The Time constant and its main usage are followings.

Time constant	3dB point(Hz)	Main usage
25	6366	FM broadcast (using Dolby-B reduction)
50	3183	FM broadcast (JIS)
75	2122	FM broadcast (FCC old standard), satellite broadcast
750	212.2	MIRS

5.3 Template Edit Function

In TRANSIENT mode, the user can change template. It is necessary to pay attention when entering template, because the data can be interpreted as a relative or absolute value, depending on the setting of Template Couple to Power ON/OFF in the Config menu.

The PASS/FAIL judgment is performed and then the result is displayed on the screen, when Template ON/OFF in the Template menu is set to ON.

5.3.1 Template Setting in the T-Domain Measuring Mode

When Template Couple to Power is set to OFF, template (Y axis data) is interpreted as an absolute value. As a result, the template consists of the data you entered.

Use the Shift X/Y keys to adjust the template position over the measured value.

When Template Couple to Power is set to ON, template (Y axis data) is interpreted as a relative value to the average power.

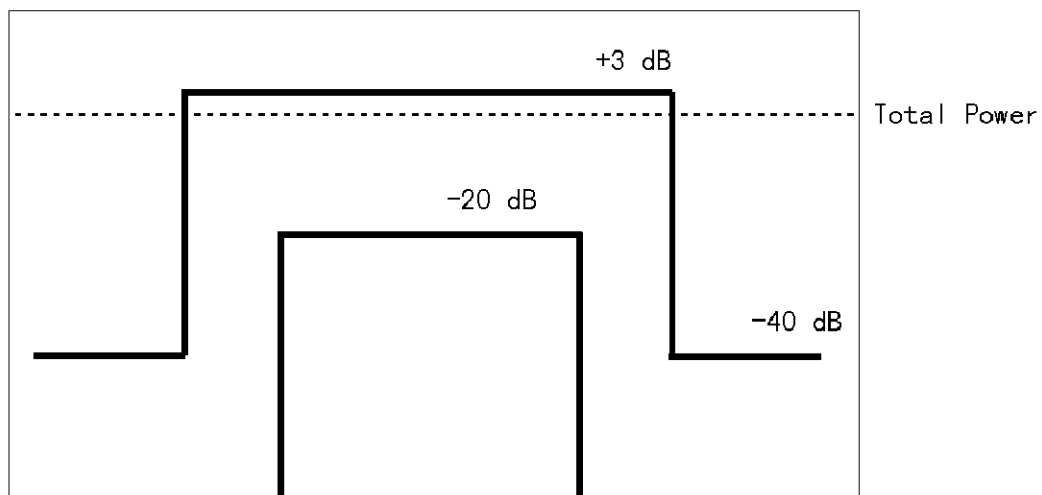

Figure 5-1 Template to Be Set

For example, the above template gives +3 dB and -40 dB of the power during the burst period of the signal. To prepare this template, follow the procedure shown below.

5.3 Template Edit Function

Set the template using the relative value to the average power.

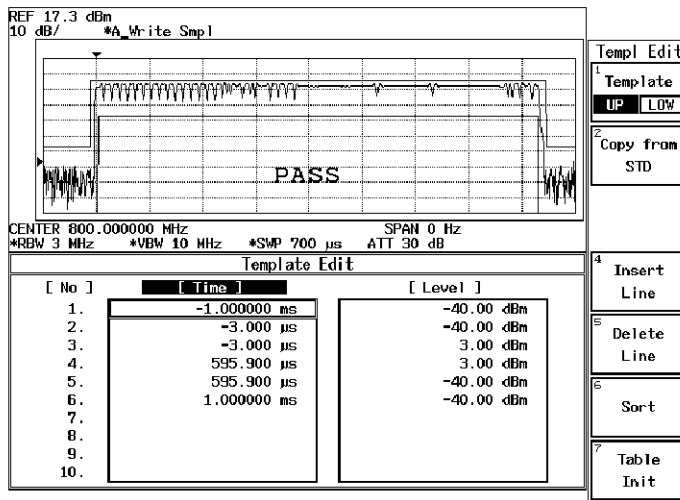

Figure 5-2 Template settings

When you shift the template to the direction of Y axis using Shift X/Y function while the Template Couple to Power is set to ON, the relative value to the average power is: Relative value (set on the template) + Shifted data on Y axis.

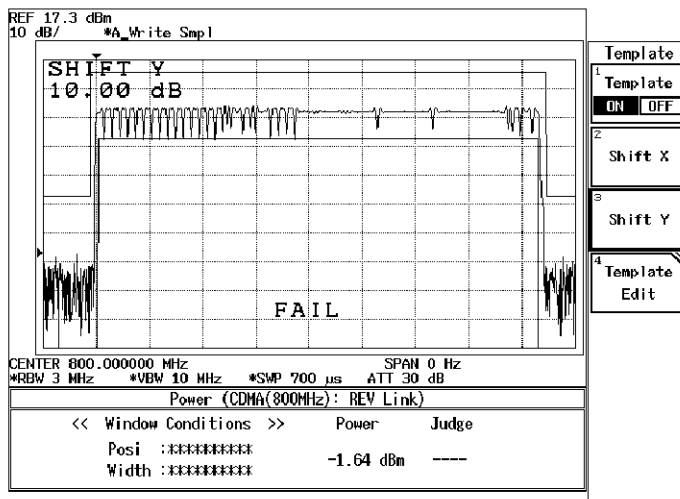

Figure 5-3 Template Shifted Using the Shift Y Function

5.3.2 Template Setting in the F-Domain Measuring Mode

In F-Domain measurement mode, the carrier frequencies depend on the channel numbers. As a result, use the offset frequency from the carrier frequency for template's X axis data.

Set the carrier frequency on the template to 0 Hz so that you can use plus or minus values for the offset frequencies.

The analyzer sets the template by adding the center frequency currently used to X value in the Shift X menu.

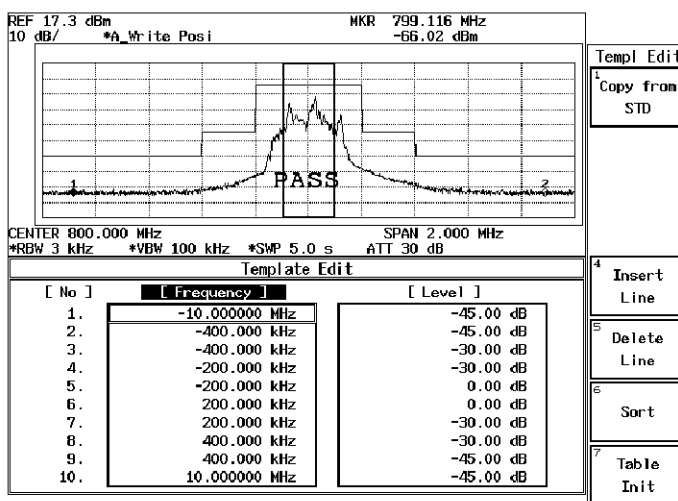

Figure 5-4 Template with the Set Values

Soft menu Margin delta X expands the template frequency by (X/2 to both sides toward plus and minus frequency directions) from the 0 Hz on the template.

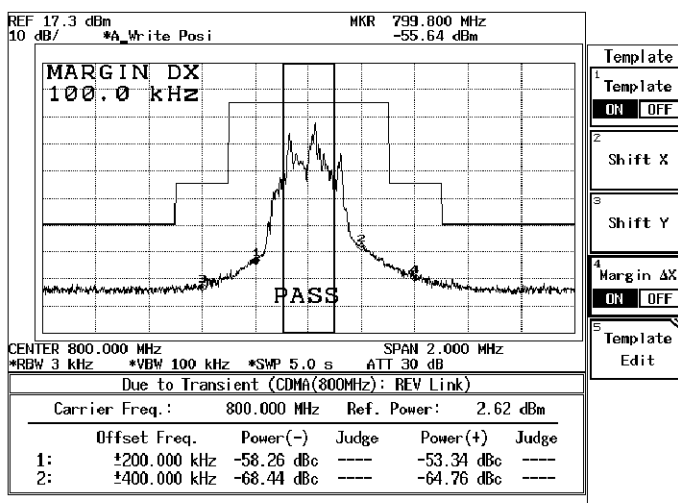

Figure 5-5 Template with Margin Delta X

5.3 Template Edit Function

When Template Couple to Power is set to OFF, template (Y axis data) is interpreted as an absolute value. As a result, the template is made up of the data you entered.

Use the Shift X/Y keys to adjust the template position over the measured value.

When Template Couple to Power is set to ON, template (Y axis data) is interpreted as a relative value to the average power.

When the template is shifted on Y axis using the Shift X/Y function, the relative value to the average power is: Relative value (set on the template) + Shifted data on Y axis.

5.4 Measurement Parameter Settings in ACP Due to Transient and Inband Spurious

In TRANSIENT mode, any parameters are compliant with the communication standard when you specify the communication standard. You can also change the measuring frequency and the secondary processing of the measured results.

For the method of changing these, refer to the following

5.4.1 Marker Edit Function

Measurement frequency can be set using Marker Edit in ACP Due to Transient or Inband Spurious function (these three functions are found within the Transient mode). In addition, each limit level can be set using Marker Edit.

(1) Marker Edit used in the ACP Due to Transient

The measuring frequency is set using the offset frequency from a carrier frequency. If you set the offset frequency to 200 kHz, the offset frequencies (+200 kHz and -200 kHz) can be measured. There are three types of markers and any of them can be set: the normal marker, integral marker and Root Nyquist.

Normal marker is used to read the level of the frequency previously set, and the Integral marker is used to calculate the power of the bandwidth whose center frequency is specified by Marker Edit. If Root Nyquist is selected, the power of the Root Nyquist filter, which is determined by the symbol rate and rolloff factor from the Parameter Setup in the Config menu, is calculated.

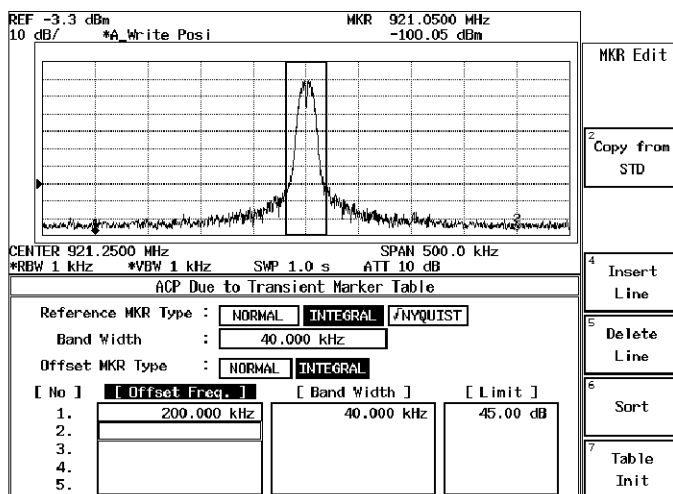

Figure 5-6 Example of Marker Edit Setting

(2) Marker Edit used in the Inband Spurious

Measuring frequency range is set using the offset frequency from the carrier frequency. If you set 3 MHz and 10 MHz, the peak search is performed for two ranges: one of the two offset frequency range is between -3 MHz and -10 MHz; another range is between +3 MHz and +10 MHz.

5.4 Measurement Parameter Settings in ACP Due to Transient and Inband Spurious

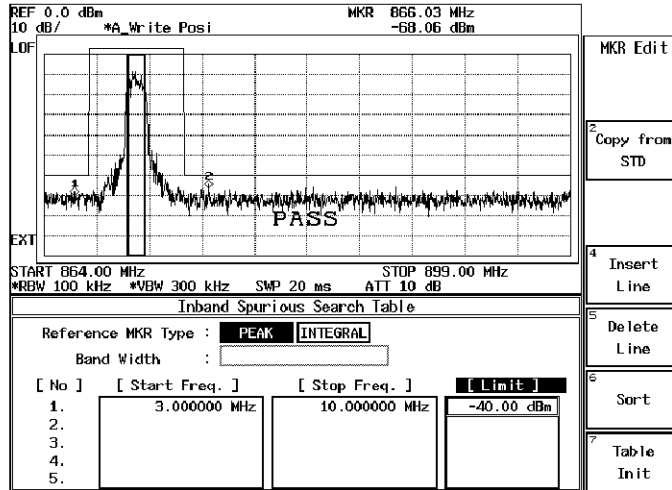

Figure 5-7 Marker Edit Setting

Peak marker is set using the Peak Marker Y Delta soft key in the Config menu.

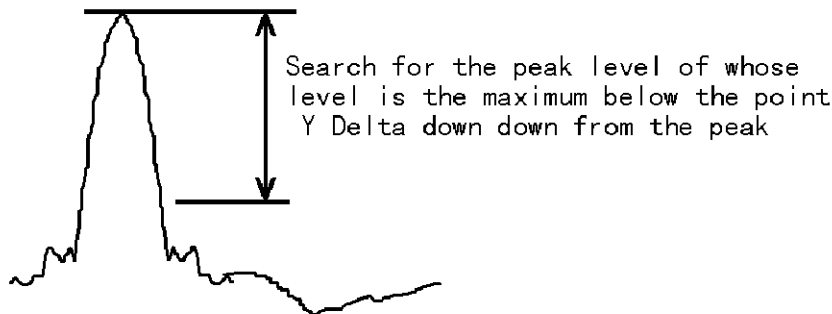

Figure 5-8 Example of Peak Marker Y Delta

5.4.2 Measurement results Using ACP Due to Transient and Inband Spurious Modes

In spectrum measurements, there are three methods for displaying results of adjacent or alternate adjacent channel leakage power measurements.

- (1) The measured value displays the absolute level of the marker, which is located at an offset frequency from the carrier frequency.
- (2) The ratio of the absolute level of the marker to the absolute level of the carrier is displayed. The marker point is located at an offset frequency from the carrier frequency.
- (3) The value obtained in (2) is multiplied by the level by the power meter. The calculated value is then displayed.

This method is used when the absolute value of the adjacent channel power cannot be measured. The ratio

5.4 Measurement Parameter Settings in ACP Due to Transient and Inband Spurious

of the adjacent channel power to the carrier power can be measured only when Detector is set to Posi. However, the absolute level cannot be measured.

To display a measured value in (1), select MARKER on the Result: MARKER/RELATIVE/ABS POWER menu in the Parameter Setup dialog box.

To display the measured value in (2), select RELATIVE.

To display a measured value in (3), select ABS POWER. In addition, use the Marker Edit menu to set up measurement conditions for the carrier power. Set the MKR Type to NORMAL, INTEGRAL or $\sqrt{\text{Nyquist}}$ in the Reference Marker in order to measure the carrier power.

To measure the power of the bandwidth by integration, Reference MKR Type must be set to INTEGRAL.

To measure a point level (marker reading), Reference MKR Type must be set to NORMAL.

To measure adjacent channel power, set Offset MKR Type to NORMAL, INTEGRAL or $\sqrt{\text{Nyquist}}$. To measure the carrier power in (2) or (3), there are two methods: one is by setting the Marker Edit to the Reference MKR type (set the Ref Power to REF MARKER. Ref Power is in the Parameter Setup dialog box on the config menu); another is to measure power using the DSP (set the Ref Power to MODULATION. Ref Power is in the Parameter Setup dialog box on the config menu).

When REF MARKER is selected, the carrier power is measured by setting Reference MKR Type in the Marker Edit menu.

When MODULATION is selected, the carrier power is measured by Tx Power (Modulation, Tx Power).

When ABS POWER of the Result is selected from the Parameter Setup dialog box in the Config Menu, the ratio of Offset MKR to Reference MKR is calculated, the measurement value from Tx Power is multiplied by this ratio. Then, the result will be displayed.

5.4.3 Measurement Result of Inband Spurious

In Spurious measurements, there are two methods:

- (1) After searching for the peak on the trace, the frequency and level at the marker are displayed.
- (2) After searching for the peak on the trace, the ratio of the marker level to the carrier level is displayed.
- (3) The calculated level, which is calculated using the result obtained in (2) and the level on the power meter is displayed.

To display the measured value in (1), select MARKER on the Result: MARKER/RELATIVE/ABS POWER menu in the Parameter Setup dialog box. And also, to display the measured value in (2), select RELATIVE; for the (3), select ABS POWER. The measurement conditions for the carrier power is set up using the Marker Edit menu. To measure the carrier power, set Reference MKR Type to PEAK or NORMAL.

To measure the carrier power at the specified frequency, NORMAL is set; and to measure the carrier power at the peak on the trace, PEAK is set.

To measure the carrier power in (2) or (3), there are two methods: one is by setting the instrument to the Reference MKR type in the Marker Edit menu; another is by the DSP.

When Ref Power is set to REF MARKER, the carrier power is measured by Reference MKR Type in the Marker Edit menu.

When Ref Power is set to MODULATION, the carrier power is measured by the Tx Power (Modulation, Tx Power).

5.5 Block Diagram

5.5 Block Diagram

This section shows the block diagram for the modulation analysis hardware.

The Figure 5-9 shows the modulation analysis part. Therefore the spectrum analyzer part is simplified. The area inside the double lines is the block diagram for the spectrum analyzer, and the part outside that area represents the modulation analysis hardware.

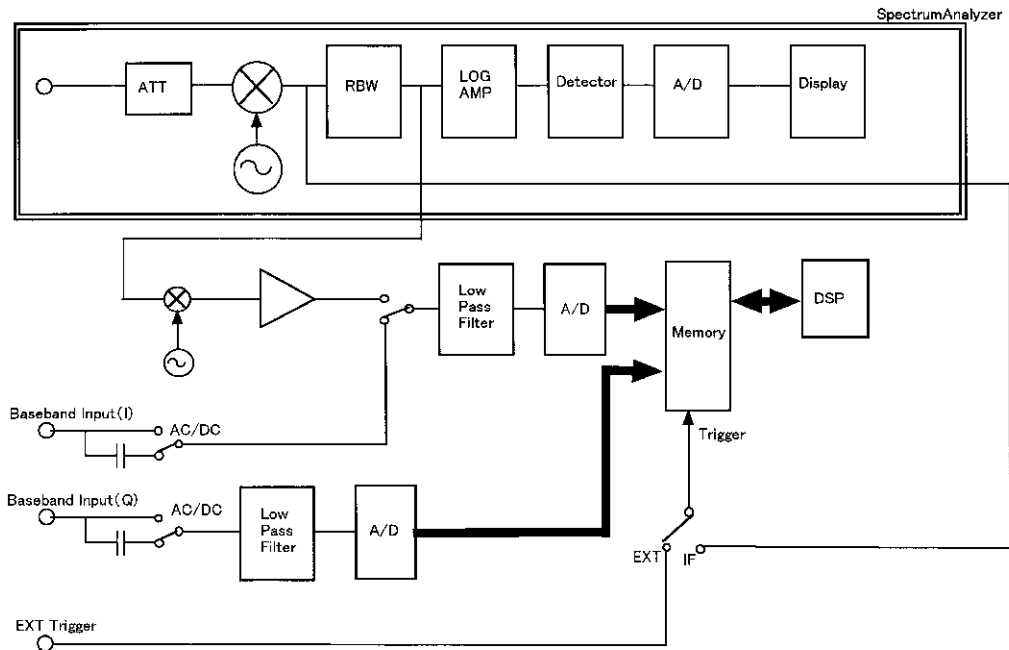

Figure 5-9 Block Diagram

6 PERFORMANCE VERIFICATION TEST

6.1 General

6.1.1 Introduction

This chapter provides R3267 Series OPT73 performance verification test procedures, item by item as listed in Table 6-1.

Performance verification test will be carried out under following condition.

Temperature range: 20 °C to 30 °C

Relative Humidity: 85 % or less

Table 6-1 Performance Verification Items

No.	Test Items
6.2.1	FM Deviation
6.2.2	Simplified Performance Check

6.1.2 Test Equipment

The Table 6-2 lists recommended test equipment.

The equipment needed to perform all of the performance test.

Equipment lists for individual tests are provided in each performance verification test.

NOTE:

1. *The R3267 Series with OPT73 to be tested should be warm up for at least 30 minutes before starting test.*
2. *Make sure that the test equipment used meets its own published specifications.*
3. *Any equipment that meets the critical specifications given in the table can be substituted for recommended models.*

Table 6-2 Equipment List

No.	Description	Critical Specification	Recommended Model	Manufacturer	Notes
1	Signal Generator	Frequency Range: Up to 30 MHz Modulation Frequency: 400 Hz FM Deviation: 0.86 kHz to 7.95 kHz	SMY	Rohde& Schwarz	SG
2	RF Cable	BNC (m)-BNC (m)	MI-09	Advantest	-
3	Adapter	Type N (m)- BNC (f)	MI-09	Advantest	-

6.1 General

6.1.3 Calibration Cycle

The performance verifications test should be used to check the spectrum analyzer against its specifications once a year recommended.

6.1.4 Performance Verification Test Record Sheets

The performance verification test record sheets and performance check record sheets are provided at the end of this chapter.

The test record lists test specification and acceptable limits.

Recommend that make a copy of this table, record the complete test results on the copy, and keep the copy for calibration test record.

This record could prove invaluable in tracking gradual changes in test result over long periods of the time.

6.1.5 Performance Verification Procedure

Typeface conventions used in this manual.

- Panel keys and soft keys are printed in a contrasting typestyle to make them stand out from the text as follows:
Panel keys: Boldface type Example: **FORMAT**
Soft keys: Boldface and Italic Example: ***Trace Detector***
- When a series of key operations are described using a comma between two keys.
- There are various soft menus used to switch between two states such as ON/OFF and AUTO/MNL. For example, when turning MNL the ***RBW AUTO/MNL*** function, the annotation ***RBW AUTO/MNL(MNL)*** is used.

6.2 Performance Verification Test Procedure

6.2.1 FM Deviation

(1) Description

Test FM deviation measurement accuracy.

Apply a signal of 30 MHz modulated by 400 Hz, then search the minimum level point while adjusting deviation $\pm 10\%$ of nominal deviation frequency.

Measure several settings of FM deviation.

Take the value of the $(P-P)/2$ [kHz] window.

(2) Specification

FM Deviation $(P-P)/2$ [kHz] $\pm 5\%$

(3) Equipment used

Signal Generator : SG

RF Cable : BNC (m)-BNC (m)

Adapter : N (m)-BNC (f)

(4) Setup

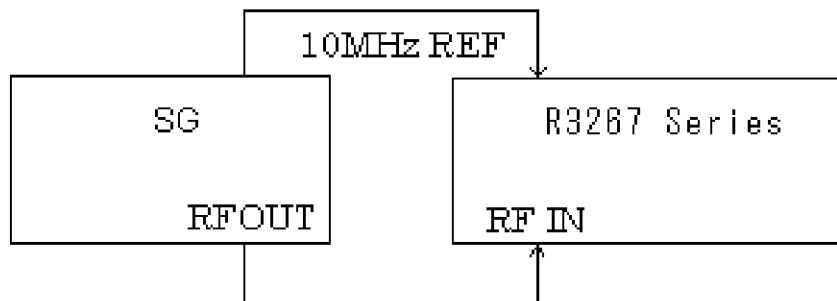

Figure 6-1 Setup of FM Deviation Test

(5) Procedure

1. Connect equipment as shown in Figure 6-1.
2. On the SG, set controls as follows;

Frequency :	30 MHz
Output Level :	0 dBm
Modulation :	FM
Modulation Frequency :	400 Hz
FM Deviation :	0.96 kHz

6.2 Performance Verification Test Procedure

3. On the R3267 Series, press **PRESET** to preset.
4. On the R3267 Series, set controls as follows;

Center Frequency : 30 MHz
 Span : 2 kHz

5. On the SG, adjust the FM deviation between 0.86 kHz to 1.06 kHz to search the signal level to be minimum while monitoring R3267 Series display as shown in Figure 6-2.

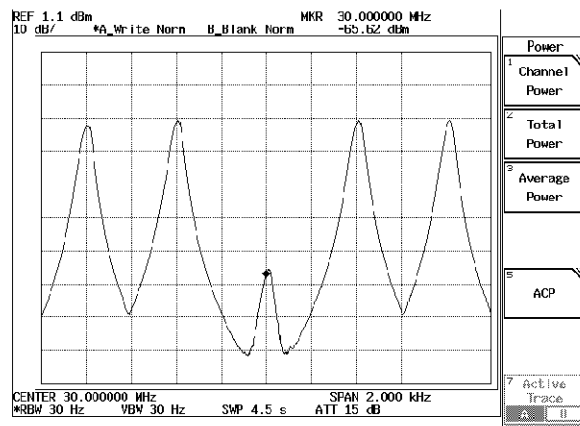

Figure 6-2 Display of Searching the Minimum FM Deviation

6. Once found the minimum FM deviation, set the value for testing.
7. On the R3267 Series, set a control as follow;

Measurement Mode : TRANSIENT

8. On the R3267 Series, set measurement parameters as shown in Figure 6-3.

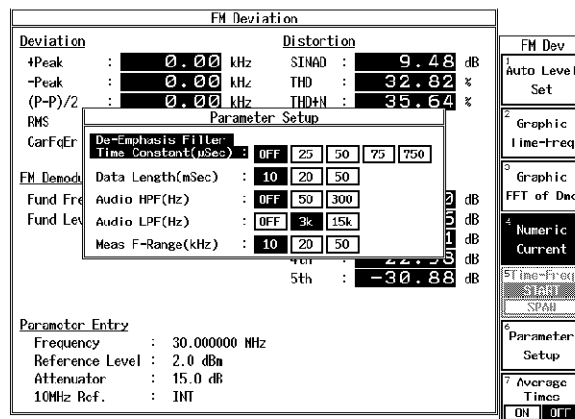

Figure 6-3 Setup of Measurement Parameters for FM Deviation Test

9. On the R3267 Series, press **DC CAL** and **AUTO LEVEL** for dc calibration and auto level.
10. On the R3267 Series, press **SINGLE** for a single sweep.
11. On the R3267 Series, after the single sweep has completed, record the measurement result of the (P-P)/2 window on the display on the performance verification test record sheet.
12. Repeat steps 2 through 12 for each FM deviation frequency listed on the Table 6-3.

Table 6-3 Setting for FM Deviation Test

Setting of FM Deviation	
Nominal (kHz)	Test Data (kHz)
2.21	1.99 to 2.43
3.46	3.11 to 3.81
4.72	4.24 to 5.19
5.97	5.37 to 6.57
7.23	6.51 to 7.95

6.2 Performance Verification Test Procedure

6.2.2 Simplified Performance Check

- (1) Description
Test FM deviation by using built-in calibration signal.
Take the value of the RMS [kHz] window.
- (2) Specification
FM Deviation, RMS [kHz] : ± 0.01 kHz
- (3) Equipment used
RF Cable : BNC (m)-BNC (m)
Adapter : N (m)- BNC (f)
- (4) Setup

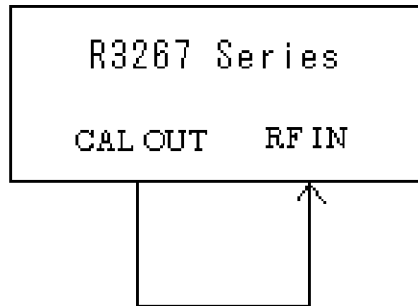

Figure 6-4 Setup of Simplified Performance Check

- (5) Procedure
 - 1. Connect equipment as shown in Figure 6-4.
 - 2. On the R3267 Series, press **PRESET** to preset.
 - 3. On the R3267 Series, set controls as follows;

Center Frequency : 30 MHz
Measurement Mode : TRANSIENT

4. On the R3267 Series, set measurement parameters as shown in Figure 6-5.

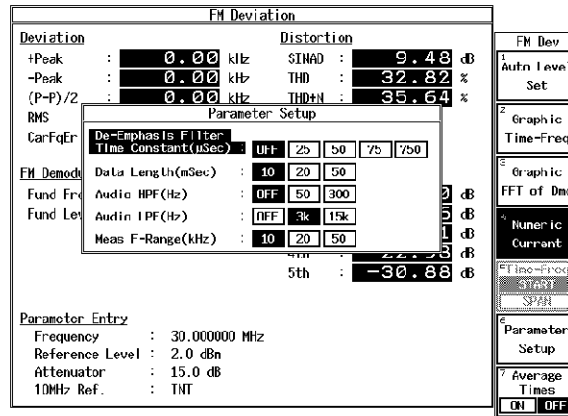

Figure 6-5 Setup of Measurement Parameters for Simplified Performance Check

5. On the R3267 Series, press **DC CAL** and **AUTO LEVEL** for dc calibration and auto level.
6. On the R3267 Series, press **SINGLE** for a single sweep.
7. On the R3267 Series, after the single sweep has completed, record the measurement result of the RMS[kHz] window on the display on the performance verification test record sheet.

6.3 Performance Verification Record Sheet

6.3 Performance Verification Record Sheet

Model: OPT3264/67/73+73

S/N :

FM Deviation Measurement, (P-P)/2 [kHz]

Test Data		Specification			Result
Modulation Frequency	Deviation [kHz] Nominal	Min. [kHz]	Measured Value [kHz]	Max. [kHz]	Pass/Fail
400 Hz	0.96	0.91		1.01	
	2.21	2.10		2.32	
	3.46	3.29		3.63	
	4.72	4.48		4.96	
	5.97	5.67		6.27	
	7.23	6.87		7.59	

6.4 Performance Check Record Sheet

Model:OPT3264/67/73+73

S/N :

FM Deviation Mesurement, RMS[kHz]

Test Data	Specification			Result
	Min. [kHz]	Measured Value [kHz]	Max. [kHz]	Pass/Fail
Frequency Deviation	-0.01		0.01	

7 SPECIFICATIONS

Measurement range:	Up to 50kHz
FM deviation measurement accuracy:	$\pm 5\%$ or less
Measurement frequency range:	10kHz/20kHz/50kHz
De-Emphasis Filter time constant:	OFF/25/50/75/750 μ sec
Audio measurement:	Measure THD, SINAD, THD+N and Harmonics using FFT of the FM demodulated signal.
Audio L.P.F:	OFF/3kHz/15kHz
Audio H.P.F:	OFF/50Hz/300Hz

APPENDIX

A.1 Messages

In this section, the messages that are displayed while the analyzer is being used are described.

Code	Messages	Description
700	System Error. Cannot allocate the required memory.	Fatal Error occurred. Data area for the calculation is insufficient on the memory. Contact a sales representative.
701	System Error. Clock is not operational.	Fatal Error occurred. System clock is not in operation. Contact a sales representative.
702	Modulation Gain CAL error. Check 30 MHz CAL signal for connection.	
703	Modulation DC CAL error. Remove input signals and try again.	
704	Time Out! No Trigger Detected	Time out error on the trigger signal occurred. Check the trigger settings.
705	Input Level is out of Range. Check the Ref. level.	
706	No graph data. Execute measurement.	
708	System Error. Contact qualified engineer.	
710	Auto Level completed !	
711	Auto Level Set can not be succeed. Signal level is not stable.	
721	Modulation Gain CAL error!(#100) Check 30 MHz CAL signal for connection.	

A.1 Messages

Code	Messages	Description
722	Modulation Gain CAL error!(#200) Check 30 MHz CAL signal for connection.	
723	Modulation Gain CAL error!(#300) Check 30 MHz CAL signal for connection.	
724	Modulation Gain CAL error!(#110) Check 30 MHz CAL signal for connection.	
725	Modulation Gain CAL error!(#120) Check 30 MHz CAL signal for connection.	
726	Modulation Gain CAL error!(#210) Check 30 MHz CAL signal for connection.	

ALPHABETICAL INDEX

[A]		Power (T-Domain).....	3-16
Accessories	1-1	Product Overview	1-1
ACP Due to Transient.....	3-27, 5-7, 5-8		
[C]		[R]	
Calibration	1-1	REFERENCE.....	3-1
Code.....	A-1, A-2	REMOTE CONTROL.....	4-1
Communication Systems	3-15		
Connectors	1-1	[S]	
		Self Test Function.....	1-1
		Specification of Test Signal.....	6-2
		SPECIFICATIONS.....	7-1
		Spurious (T-Domain).....	3-21
[F]		[T]	
F-Domain	3-23	T-Domain.....	3-15
Functional Description.....	3-14	TECHNICAL INFORMATION.....	5-1
		Template Edit function	5-3
		Template Setting in the F-Domain	
		Measuring Mode.....	5-5
		Template Setting in the T-Domain	
		Measuring Mode.....	5-3
		Test Equipment.....	6-1
[G]			
GPIB Command Codes.....	4-6		
GPIB Command Index.....	4-1		
[I]			
Inband Spurious	3-29, 5-7, 5-9		
Inband Spurious Modes	5-8		
INTRODUCTION	1-1		
[M]			
Marker Edit Function.....	5-7		
Menu Index	3-1		
Menu Map.....	3-4		
Messages.....	A-1		
[O]			
OBW	3-26		
ON/OFF Ratio.....	3-19		
OPERATION.....	2-1		
Outband Spurious	3-31		
[P]			
Performance.....	6-8		
Performance Check Record Sheet			
for W-CDMA.....	6-8		
Performance Verification Record Sheet			
for W-CDMA Measurement.....	6-8		
PERFORMANCE VERIFICATION TEST			
(NTT DoCoMo).....	6-1		
Power (F-Domain).....	3-23		

IMPORTANT INFORMATION FOR ADVANTEST SOFTWARE

PLEASE READ CAREFULLY: This is an important notice for the software defined herein. Computer programs including any additions, modifications and updates thereof, operation manuals, and related materials provided by Advantest (hereafter referred to as "SOFTWARE"), included in or used with hardware produced by Advantest (hereafter referred to as "PRODUCTS").

SOFTWARE License

All rights in and to the SOFTWARE (including, but not limited to, copyright) shall be and remain vested in Advantest. Advantest hereby grants you a license to use the SOFTWARE only on or with Advantest PRODUCTS.

Restrictions

- (1) You may not use the SOFTWARE for any purpose other than for the use of the PRODUCTS.
- (2) You may not copy, modify, or change, all or any part of, the SOFTWARE without permission from Advantest.
- (3) You may not reverse engineer, de-compile, or disassemble, all or any part of, the SOFTWARE.

Liability

Advantest shall have no liability (1) for any PRODUCT failures, which may arise out of any misuse (misuse is deemed to be use of the SOFTWARE for purposes other than its intended use) of the SOFTWARE. (2) For any dispute between you and any third party for any reason whatsoever including, but not limited to, infringement of intellectual property rights.

LIMITED WARRANTY

1. Unless otherwise specifically agreed by Seller and Purchaser in writing, Advantest will warrant to the Purchaser that during the Warranty Period this Product (other than consumables included in the Product) will be free from defects in material and workmanship and shall conform to the specifications set forth in this Operation Manual.
2. The warranty period for the Product (the "Warranty Period") will be a period of one year commencing on the delivery date of the Product.
3. If the Product is found to be defective during the Warranty Period, Advantest will, at its option and in its sole and absolute discretion, either (a) repair the defective Product or part or component thereof or (b) replace the defective Product or part or component thereof, in either case at Advantest's sole cost and expense.
4. This limited warranty will not apply to defects or damage to the Product or any part or component thereof resulting from any of the following:
 - (a) any modifications, maintenance or repairs other than modifications, maintenance or repairs (i) performed by Advantest or (ii) specifically recommended or authorized by Advantest and performed in accordance with Advantest's instructions;
 - (b) any improper or inadequate handling, carriage or storage of the Product by the Purchaser or any third party (other than Advantest or its agents);
 - (c) use of the Product under operating conditions or environments different than those specified in the Operation Manual or recommended by Advantest, including, without limitation, (i) instances where the Product has been subjected to physical stress or electrical voltage exceeding the permissible range and (ii) instances where the corrosion of electrical circuits or other deterioration was accelerated by exposure to corrosive gases or dusty environments;
 - (d) use of the Product in connection with software, interfaces, products or parts other than software, interfaces, products or parts supplied or recommended by Advantest;
 - (e) incorporation in the Product of any parts or components (i) provided by Purchaser or (ii) provided by a third party at the request or direction of Purchaser or due to specifications or designs supplied by Purchaser (including, without limitation, any degradation in performance of such parts or components);
 - (f) Advantest's incorporation or use of any specifications or designs supplied by Purchaser;
 - (g) the occurrence of an event of force majeure, including, without limitation, fire, explosion, geological change, storm, flood, earthquake, tidal wave, lightning or act of war; or
 - (h) any negligent act or omission of the Purchaser or any third party other than Advantest.
5. **EXCEPT TO THE EXTENT EXPRESSLY PROVIDED HEREIN, ADVANTEST HEREBY EXPRESSLY DISCLAIMS, AND THE PURCHASER HEREBY WAIVES, ALL WARRANTIES, WHETHER EXPRESS OR IMPLIED, STATUTORY OR OTHERWISE, INCLUDING, WITHOUT LIMITATION, (A) ANY WARRANTY OF MERCHANTABILITY OR FITNESS FOR A PARTICULAR PURPOSE AND (B) ANY WARRANTY OR REPRESENTATION AS TO THE VALIDITY, SCOPE, EFFECTIVENESS OR USEFULNESS OF ANY TECHNOLOGY OR ANY INVENTION.**
6. **THE REMEDY SET FORTH HEREIN SHALL BE THE SOLE AND EXCLUSIVE REMEDY OF THE PURCHASER FOR BREACH OF WARRANTY WITH RESPECT TO THE PRODUCT.**
7. **ADVANTEST WILL NOT HAVE ANY LIABILITY TO THE PURCHASER FOR ANY INDIRECT, INCIDENTAL, SPECIAL, CONSEQUENTIAL OR PUNITIVE DAMAGES, INCLUDING, WITHOUT LIMITATION, LOSS OF ANTICIPATED PROFITS OR REVENUES, IN ANY AND ALL CIRCUMSTANCES, EVEN IF ADVANTEST HAS BEEN ADVISED OF THE POSSIBILITY OF SUCH DAMAGES AND WHETHER ARISING OUT OF BREACH OF CONTRACT, WARRANTY, TORT (INCLUDING, WITHOUT LIMITATION, NEGLIGENCE), STRICT LIABILITY, INDEMNITY, CONTRIBUTION OR OTHERWISE. TORT (INCLUDING, WITHOUT LIMITATION, NEGLIGENCE), STRICT LIABILITY, INDEMNITY, CONTRIBUTION OR OTHERWISE.**
8. **OTHER THAN THE REMEDY FOR THE BREACH OF WARRANTY SET FORTH HEREIN, ADVANTEST SHALL NOT BE LIABLE FOR, AND HEREBY DISCLAIMS TO THE FULLEST EXTENT PERMITTED BY LAW ANY LIABILITY FOR, DAMAGES FOR PRODUCT FAILURE OR DEFECT, WHETHER ARISING OUT OF BREACH OF CONTRACT, TORT (INCLUDING, WITHOUT LIMITATION, NEGLIGENCE), STRICT LIABILITY, INDEMNITY, CONTRIBUTION OR OTHERWISE.**

CUSTOMER SERVICE DESCRIPTION

In order to maintain safe and trouble-free operation of the Product and to prevent the incurrence of unnecessary costs and expenses, Advantest recommends a regular preventive maintenance program under its maintenance agreement.

Advantest's maintenance agreement provides the Purchaser on-site and off-site maintenance, parts, maintenance machinery, regular inspections, and telephone support and will last a maximum of ten years from the date the delivery of the Product. For specific details of the services provided under the maintenance agreement, please contact the nearest Advantest office listed at the end of this Operation Manual or Advantest's sales representatives.

Some of the components and parts of this Product have a limited operating life (such as, electrical and mechanical parts, fan motors, unit power supply, etc.). Accordingly, these components and parts will have to be replaced on a periodic basis. If the operating life of a component or part has expired and such component or part has not been replaced, there is a possibility that the Product will not perform properly. Additionally, if the operating life of a component or part has expired and continued use of such component or part damages the Product, the Product may not be repairable. Please contact the nearest Advantest office listed at the end of this Operation Manual or Advantest's sales representatives to determine the operating life of a specific component or part, as the operating life may vary depending on various factors such as operating condition and usage environment.

SALES & SUPPORT OFFICES

Advantest Korea Co., Ltd.

22BF, Kyobo KangNam Tower,
1303-22, Seocho-Dong, Seocho-Ku, Seoul #137-070, Korea
Phone: +82-2-532-7071
Fax: +82-2-532-7132

Advantest (Suzhou) Co., Ltd.

Shanghai Branch Office:
Bldg. 6D, NO.1188 Gumei Road, Shanghai, China 201102 P.R.C.
Phone: +86-21-6485-2725
Fax: +86-21-6485-2726

Shanghai Branch Office:
406/F, Ying Building, Quantum Plaza, No. 23 Zhi Chun Road,
Hai Dian District, Beijing,
China 100083
Phone: +86-10-8235-3377
Fax: +86-10-8235-6717

Advantest (Singapore) Pte. Ltd.

438A Alexandra Road, #08-03/06
Alexandra Technopark Singapore 119967
Phone: +65-6274-3100
Fax: +65-6274-4055

Advantest America, Inc.

3201 Scott Boulevard, Suite, Santa Clara, CA 95054, U.S.A
Phone: +1-408-988-7700
Fax: +1-408-987-0691

ROHDE & SCHWARZ Europe GmbH

Mühldorfstraße 15 D-81671 München, Germany
(P.O.B. 80 14 60 D-81614 München, Germany)
Phone: +49-89-4129-13711
Fax: +49-89-4129-13723

ADVANTEST[®]

<http://www.advantest.co.jp>